



# User Manual

Version 1.0.6 April. 2019

# GTP-541M

(4G Intelligent Multi-Function Controller)



## Table of Contents

---

<b>1. Introduction .....</b>	<b>1</b>
1.1 Features.....	3
1.2 Specification.....	6
<b>2. Hardware appearance .....</b>	<b>7</b>
2.1 LED indicator .....	9
2.2 Installing the antenna and SIM card.....	10
2.3 DI/DO wiring method.....	11
2.3.1 DI Wiring Instructions .....	11
2.3.2 DO wiring instructions .....	11
<b>3. Environment settings before installing GTP-541M Utility.....</b>	<b>12</b>
3.1 Installing M2M_Utility .....	13
<b>4. Turn on the Utility operation instructions .....</b>	<b>16</b>
4.1 GTP-541M enters the Utility Mode Operating Instructions .....	18
<b>5. ModBusSMS Utility main screen description .....</b>	<b>19</b>
5.1 Layout Introduction .....	20
5.2 Parameter File Management.....	22
5.3 Description of parameter options .....	23
5.3.1 Description of System Parameters .....	23
5.3.2 COM Port Parameter Description.....	24
5.3.3 Phone Book Parameter Description .....	25
5.3.4 Alarm Message Parameter Description.....	26
5.4 Download and upload parameters .....	28
5.5 Learning Modbus RTU Commands and Testing.....	29
5.6 System function .....	32
5.6.1 Querying the signal strength of the module .....	32
5.6.2 Querying the Firmware Version .....	32
5.6.3 Restarting GTP-541M .....	33
5.6.4 Reply to factory defaults.....	33
5.6.5 Voice file format and status .....	34

5.7	Using the sample description .....	36
5.7.1	Example 1: Sending the general alarm SMS (Level Trigger).....	36
5.7.2	Example 2: Variable SMS Alerts .....	41
5.7.3	Example 3: Dynamic SMS alert.....	45
5.7.4	Example 4: Receiving a newsletter .....	48
5.7.5	Example 5: Sending the general alarm SMS (Edge Trigger).....	54
5.7.6	Example 6: Sending the alarm voice .....	58
<b>6.</b>	<b>DIOSMS Utility main screen description .....</b>	<b>62</b>
6.1	Main parameters .....	65
6.1.1	Description of the Event Parameter.....	65
6.2	SMS Record Description.....	73
6.2.1	Auto-Report report.....	73
6.2.2	Event record query .....	75
6.3	Device Time Parameter Description.....	77
6.4	Device Parameter Parameter Description.....	78
6.5	DO Control AI/DI Status Description .....	81
6.6	Signal Quality Description .....	83
6.7	Version Information Description .....	84
6.8	System Description .....	85
6.8.1	ReCover to Factory Settings Instructions .....	85
6.8.2	Reset Device Description .....	85
6.9	Voice file format, status and on .....	86
6.10	SMS instruction description.....	90
6.10.1	@TIME(Time setting / query) .....	91
6.10.2	@DOCn(DO control) .....	92
6.10.3	@ACTV(Count value query).....	93
6.10.4	@DIV(DI/DO status query) .....	94
6.10.5	@AIV (AI status query).....	95
6.11	DIOSMS usage examples.....	96
<b>7.</b>	<b>RMV Utility main screen description .....</b>	<b>106</b>
7.1	Parameter File Management.....	108
7.2	Connection GTP-541M .....	109
7.3	Parameter Description .....	110

7.3.1	Description of System Parameters .....	110
7.4	Download and upload parameters .....	112
7.5	Query signal strength .....	113
7.6	Back to factory defaults .....	114
7.7	connection test.....	115
7.8	Restart .....	116
7.9	Setting VxServer and VxComm Driver .....	117
7.10	Virtual COM Connection Example.....	121
<b>8.</b>	<b>TXTSMS Utility main screen description.....</b>	<b>129</b>
8.1	Parameter File Management.....	131
8.2	Description of parameter options Click on the left window, the tree parameter option, the right side will display the parameter content in the parameter option, select the content you want to change, you can modify it, as shown below:.....	132
8.2.1	Description of System Parameters .....	132
8.2.2	Phone Book Parameter Description .....	133
8.2.3	Alarm Message Parameter Description .....	134
8.3	Download and Upload Parmeters .....	135
8.4	Query signal strength .....	136
8.5	Back to factory defaults .....	137
8.6	UCS2 Conversion Tool.....	138
8.7	SMS Command Description.....	139
8.7.1	@ALARM(Send fixed message) .....	139
8.7.2	@SMSSEND(Send Dynamic ASCII Message).....	140
8.7.3	@SMSSENDUCS2(Send dynamic UCS2 Message) .....	140
<b>9.</b>	<b>Update Firmware Instructions from SD Card.....</b>	<b>142</b>
<b>10.</b>	<b>GTP-541M Modbus Position Configuration Table .....</b>	<b>160</b>
	<b>Appendix A. Manual Revision History.....</b>	<b>164</b>

## Important Information

### Warranty

---

All products manufactured by ICP DAS are under warranty regarding defective materials for a period of one year, beginning from the date of delivery to the original purchaser.

### Warning

---

ICP DAS assumes no liability for any damage resulting from the use of this product. ICP DAS reserves the right to change this manual at any time without notice. The information furnished by ICP DAS is believed to be accurate and reliable. However, no responsibility is assumed by ICP DAS for its use, not for any infringements of patents or other rights of third parties resulting from its use.

### Copyright

---

Copyright © 2018 by ICP DAS Co., Ltd. All rights are reserved.

### Trademark

---

Names are used for identification purpose only and may be registered trademarks of their respective companies.

### Contact us

---

If you encounter any problems while operating this device, feel free to contact us via mail at: [service@icpdas.com](mailto:service@icpdas.com) . We guarantee to respond within 2 working days.

# 1. Introduction

The GTP-541M is an industrial smart 4G remote terminal device that is backward compatible with the 2G/3G frequency band and can be used with different software interfaces to meet user needs.

4G remote terminal equipment transmits I/O signals to the remote management platform through LTE/WCDMA/GPRS. ICP also provides related software support to facilitate customers to quickly establish monitoring programs. These softwares include VxServer. Virtual COM software such as VxComm.

In addition, users can switch GTP-541M different functions such as ModBusSMS, DIOSMS and RMV through SD card replacement firmware to meet different application requirements. The powerful features of the GTP-541M reduce user development costs and time, making it ideal for IoT applications.



### Virtual software - VxServer

VxServer is virtual com mediation software. VxServer with VxComm Driver can establish virtual COM port(s) and can be mapped to the physical sequence on GTP-541M /M2M-710D/M2M-711D via Ethernet, GPRS, 4G, Wi-Fi and other networks.

Detailed description and software download: [http://m2m.icpdas.com/VxServer\\_TC.html](http://m2m.icpdas.com/VxServer_TC.html)

### Virtual software - VxComm

The VxComm Driver creates a virtual COM port(s) and maps to the entity sequence on the 7188E/8000E/PDS via Ethernet. The user's RS-232 client program only needs to be connected to the virtual COM port to access the serial device on the Internet or Ethernet via PDS/DS/TDS/7188E/8000E.

Detailed description and software download: [http://www.icpdas.com/vxcomm\\_tc.html](http://www.icpdas.com/vxcomm_tc.html)

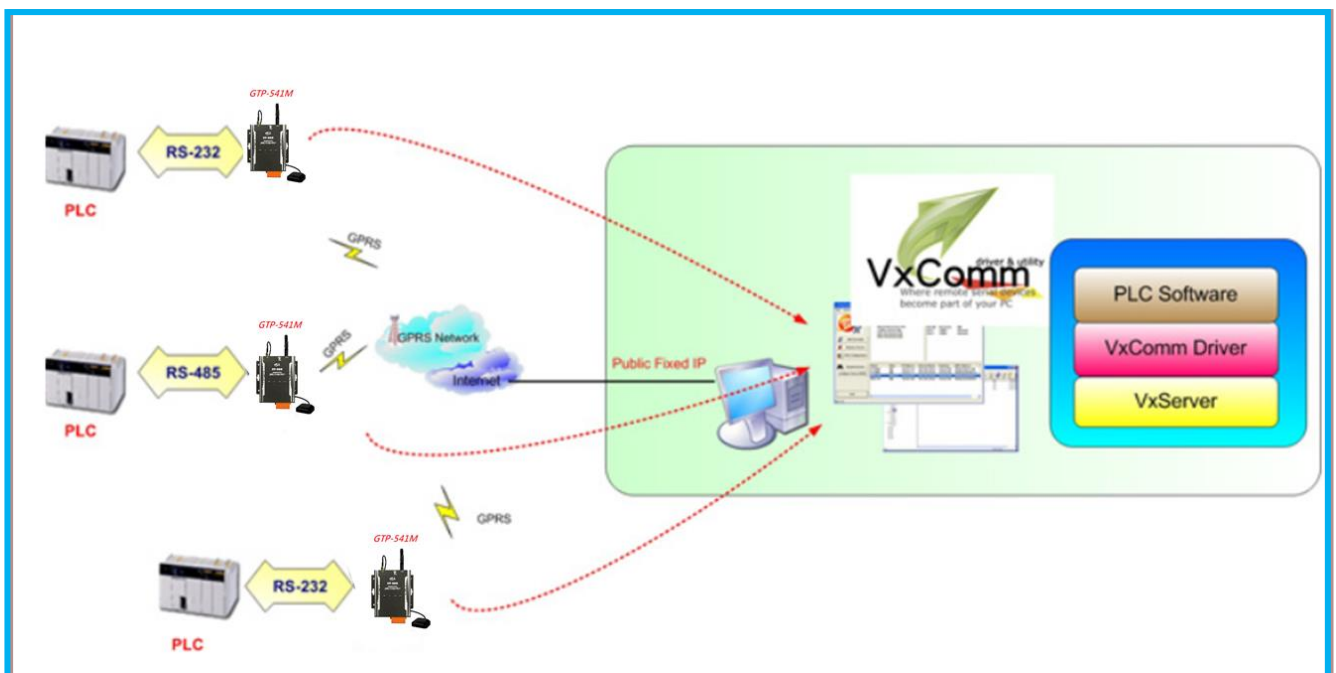

# 1.1 Features

## ■ Soft and hard

- ◆ Support input voltage +10 VDC ~30VDC
- ◆ Power supply reverse protection
- ◆ LTE LTE supports B1/B3/B8/B38/B39/B40/B41 bands
- ◆ WCDMA supports 900/2100 MHz dual frequency
- ◆ GSM GSM/GPRS support 900/1800 MHz dual frequency
- ◆ 1 utility port for parameter setting
- ◆ 5 groups of DI, 2 groups of DO, 4 groups of AI, 1 group of RS-232 and 1 group of RS-485 communication interfaces
- ◆ Support Modbus SMS function
  - Provide phone group function, you can specify up to 256 phone numbers
  - Support up to 256 newsletters
  - SMS content up to 70 Unicode characters
  - Customizable newsletter content
  - Change the content of the newsletter through the Modbus RTU command
  - Support multi-language newsletter and phone format
- ◆ Support DIO SMS function
  - There are 16 events each group can set 10 groups of receiving phone numbers!
  - SMS content up to 160 ASCII characters or 70 Unicode characters
  - Support multi-language newsletter and phone format
  - Support SMS settings and control functions
  - DI contacts provide NC (normally closed), NO (normally open) and Counter event



settings

- AI alarm settings
- Automatically report DI/DO/AI/Counter status at regular intervals

- ◆ Support for Virtual Serial Technology (RMV)
- ◆ Send SMS via RS-232 communication serial port

## ■ Application

- ◆ Automated watering equipment monitoring
- ◆ Farmland and water conservancy automation control system
- ◆ Factory, warehouse and home security
- ◆ Equipment or machine condition monitoring

## SMS DIO/Modbus function



## RMV function

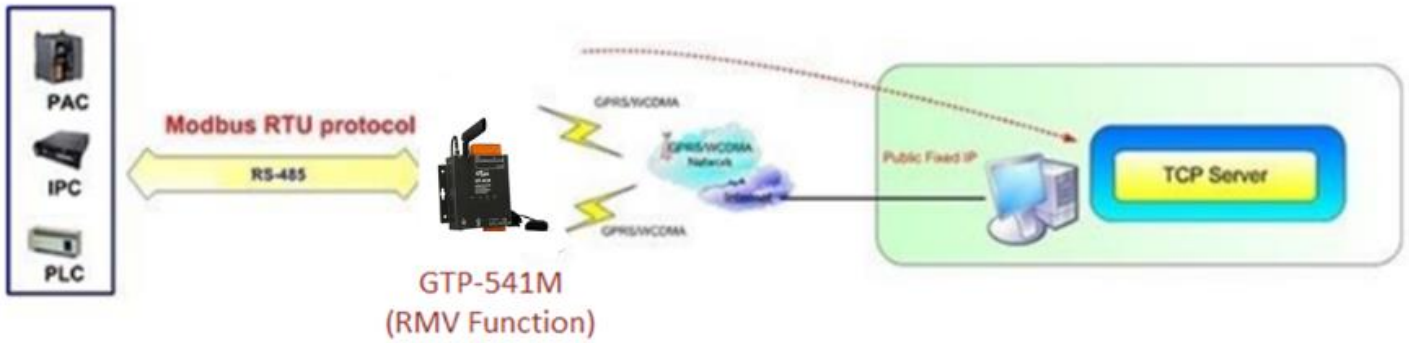

## 1.2 Specification

Module	GTP-541M
<b>System</b>	
CPU	ARM Cortex™ A5 processor
<b>4G System</b>	
LTE-FDD Band	B1/B3/B8
LTE-TDD Band	B38/B39/B40/B41
<b>3G System</b>	
Frequency Band	900/2100 MHz
Power Class	Class 3(250mW @ WCDMA/HSPA)
<b>2G System</b>	
Frequency Band	900/1800 MHz
Power Class	Class 4 (2 W @ 900 MHz)
	Class 1 (1 W @ 1800 MHz)
<b>Serial Ports</b>	
Utility Port(COM 1)	RS-232:TxD, RxD, GND
COM 1	RS-485: D+, D-
Baud Rate	9600 · 19200 · 38400 · 57600 and 115200 bps
<b>Power</b>	
Protection	Power reverse polarity protection
Frame Ground Protection	ESD, Surge, EFT, Hi-Pot
Required Supply Voltage	+10 VDC ~ +30 VDC
<b>Mechanical</b>	
Casing	Metal
Dimensions(W x L x H)	125 mm x 113 mm x 33 mm
<b>Environment</b>	
Operating Temperature	-25 °C ~ +75 °C
Storage Temperature	-30 °C ~ +80 °C
Relative Humidity	5 ~ 95% RH, non-condensing

## 2. Hardware appearance

### ■ Appearance and foot configuration (lower side)

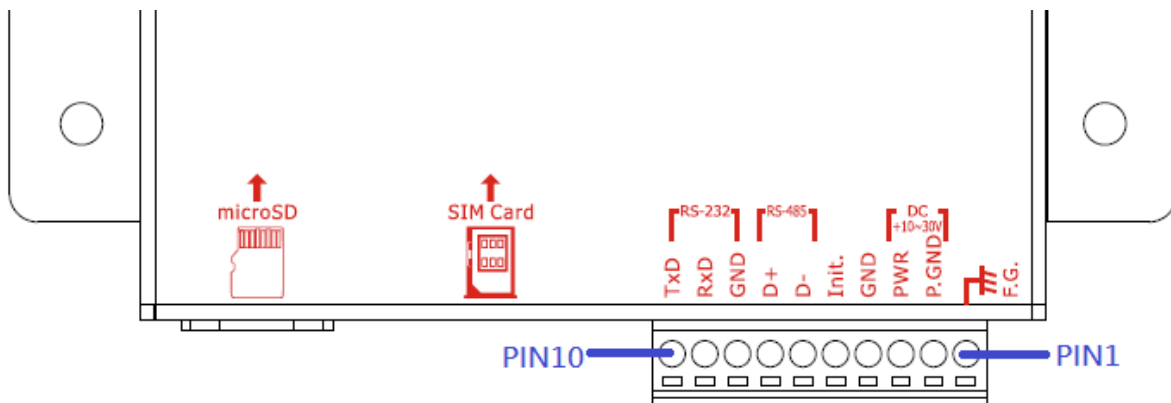

COM Port and Power Input		
Pin		Description
Frame Ground	1	F.G
Power Input : +10V <sub>DC</sub> ~ +30V <sub>DC</sub>	2	P.GND
	3	PWR
Init.	4	GND
	5	Init.
COM 1 RS-485	6	D-
	7	D+
COM 1 Utility Port RS-232	8	GND
	9	RxD
	10	TxD

■ Appearance and foot configuration (upper side)

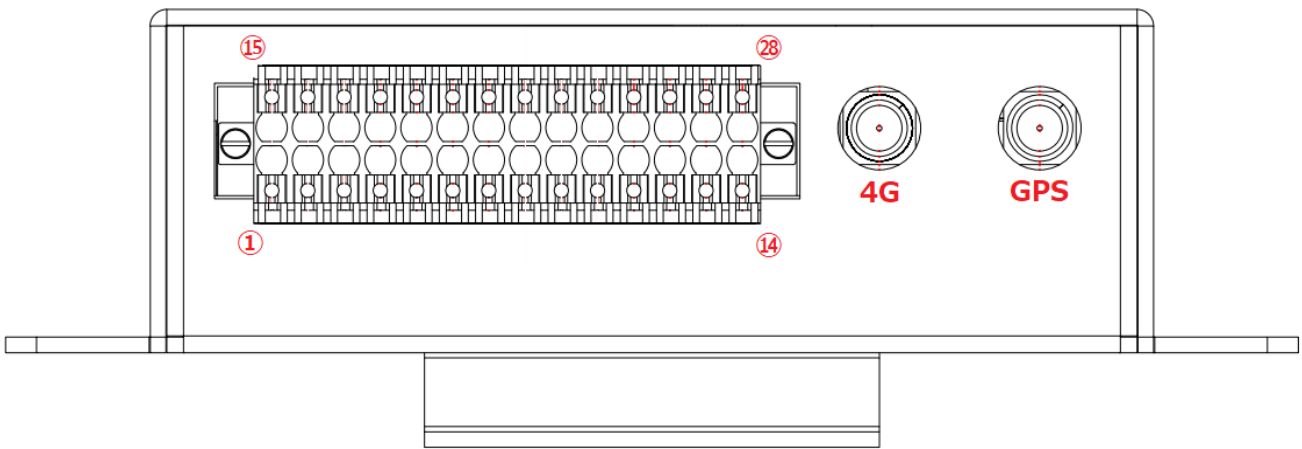

DI/DO Port					
Pin		Description	Pin		Description
AI	1	AI0 +	AI	15	AI2 +
	2	AI0 GND		16	AI2 GND
	3	AI1 +		17	AI3 +
	4	AI1 GND		18	AI3 GND
DI	5	DI.COM	Extended Option	19	
	6	DI0		20	
	7	DI1		21	
	8	DI2		22	
	9	DI3		23	
	10	DI4		24	
DO	11	DO1		25	
	12	DO0		26	
DI/DO Power	13	Ext.PWR		27	
	14	Ext.GND		28	

## 2.1 LED indicator

The GTP-541M provides four LED indicators. The table below will indicate the status indication of the LED light.



LED Name	LED Status	LED Description
<b>PWR (Red)</b>	ON	The power of the module is ON
	OFF	The power of the module is OFF
<b>4G (Green)</b>	Flash once every 1 second	4G module is normal (standby mode)
	Flashes twice in 1 second	4G module is normal (online mode)
	not bright	4G modem fail
<b>STA (Orange)</b>	Flashes every 0.9 seconds	Completed registration with the base station
	Flashes every 0.5 seconds	Network function registration is completed
	Flashes every 0.2 seconds	Communicating with the remote device
	not bright	System internal preparation
<b>GPS(Green)</b>	Flash once per second	GPS successfully positioned
	Hengliang	GPS is not yet positioned

## 2.2 Installing the antenna and SIM card

- (1) Install 4G antenna and GPS antenna
- (2) Insert a confirmed SIM card (test with your phone first)
- (3) Connect DC.+VS (PIN3) and DC.GND (PIN2) to the power supply

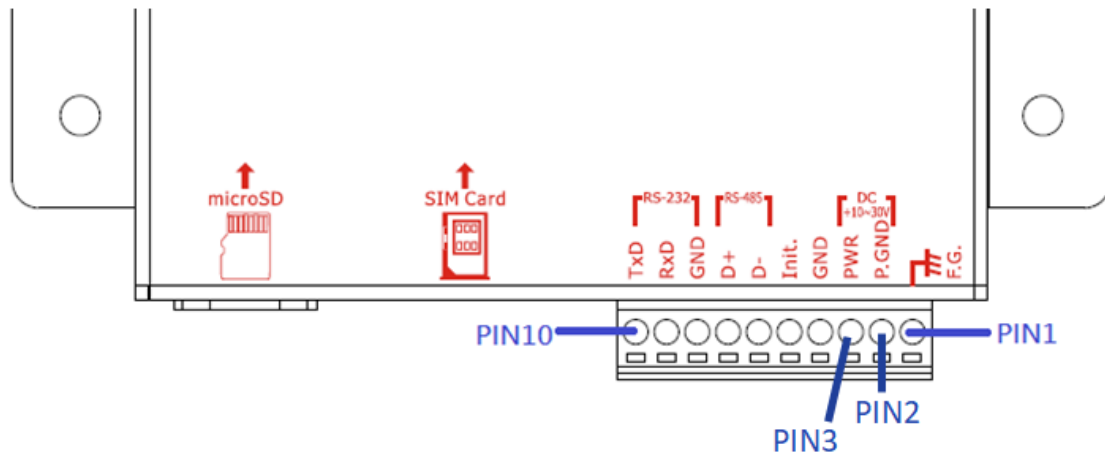

### Tips & Warnings



The product case may be hot and do not touch until the case has cooled, otherwise it may be burnt.

## 2.3 DI/DO wiring method

### 2.3.1 DI Wiring Instructions

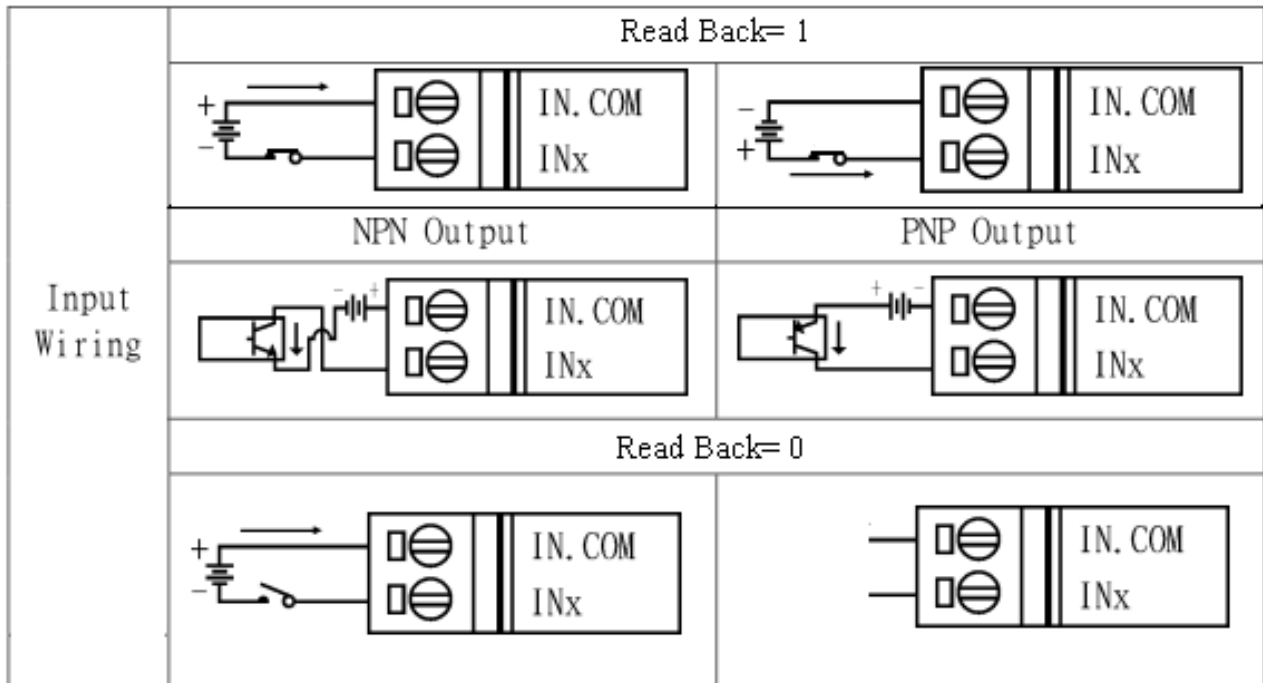

### 2.3.2 DO wiring instructions

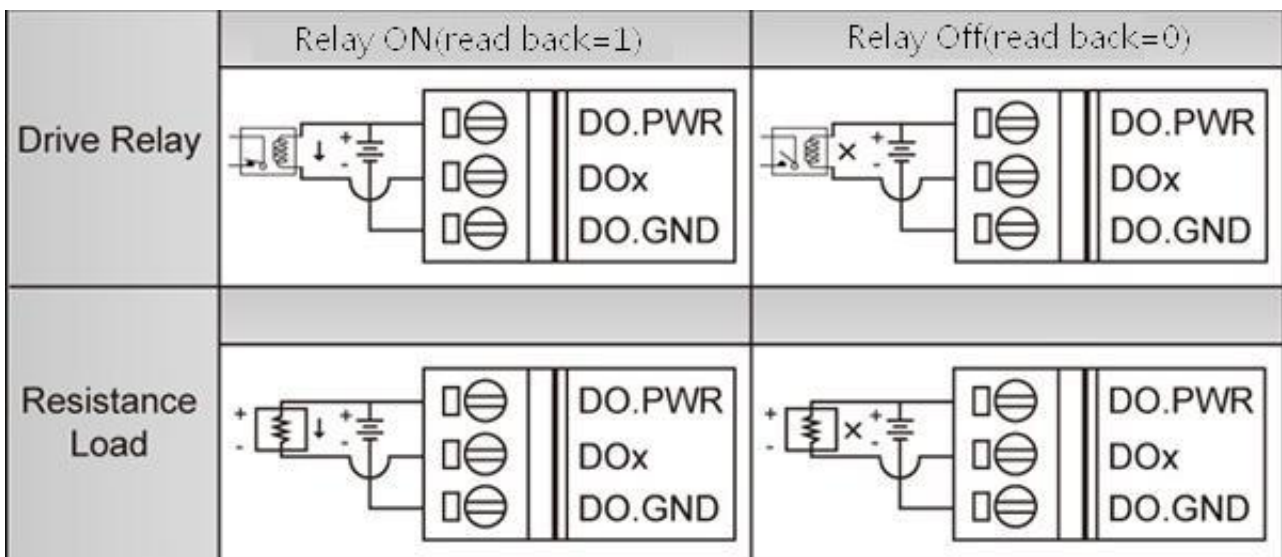



## 3. Environment settings before installing GTP-541M

### Utility

Users can use the GTP-541M Utility to set parameters or view debug messages. This program requires a .NET Framework 2.0 or higher runtime environment to be executed on the PC. You can download .NET Framework 2.0 and .NET Framework 3.5 from the following URL.

- ◆ Microsoft .NET Framework 2.0

[https : //www.microsoft.com/en-us/download/details.aspx?id=1639](https://www.microsoft.com/en-us/download/details.aspx?id=1639)

- ◆ Microsoft .NET Framework 3.5

[https : //www.microsoft.com/en-us/download/details.aspx?id=21](https://www.microsoft.com/en-us/download/details.aspx?id=21)

## 3.1 Installing M2M\_Utility

Insert the installation CD and execute \GTP-541M\Software\M2M\_Setup\_V110.exe. The installation screen is as follows:

(1) Press "Next" to start the installation

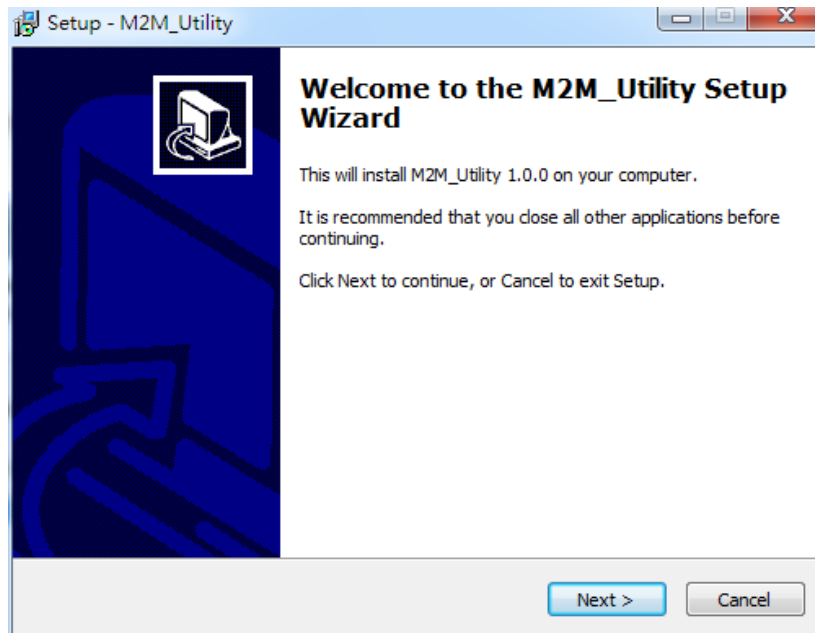

(2) Select the installation directory, the default path is "C:\ICPDAS\M2M\_Utility", after confirming, press "Next" to continue

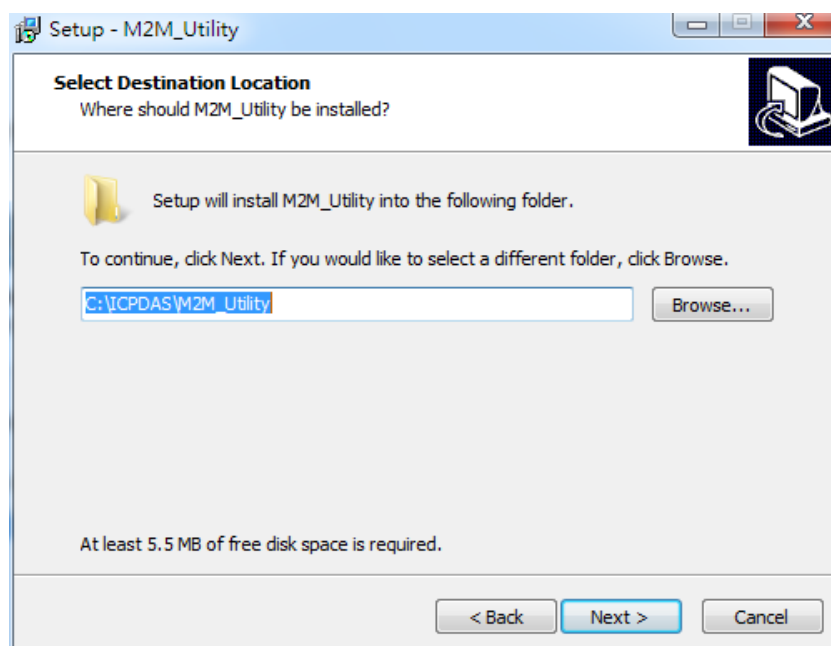

(3) Select the path in "All Programs", after confirming, press "Next" to continue

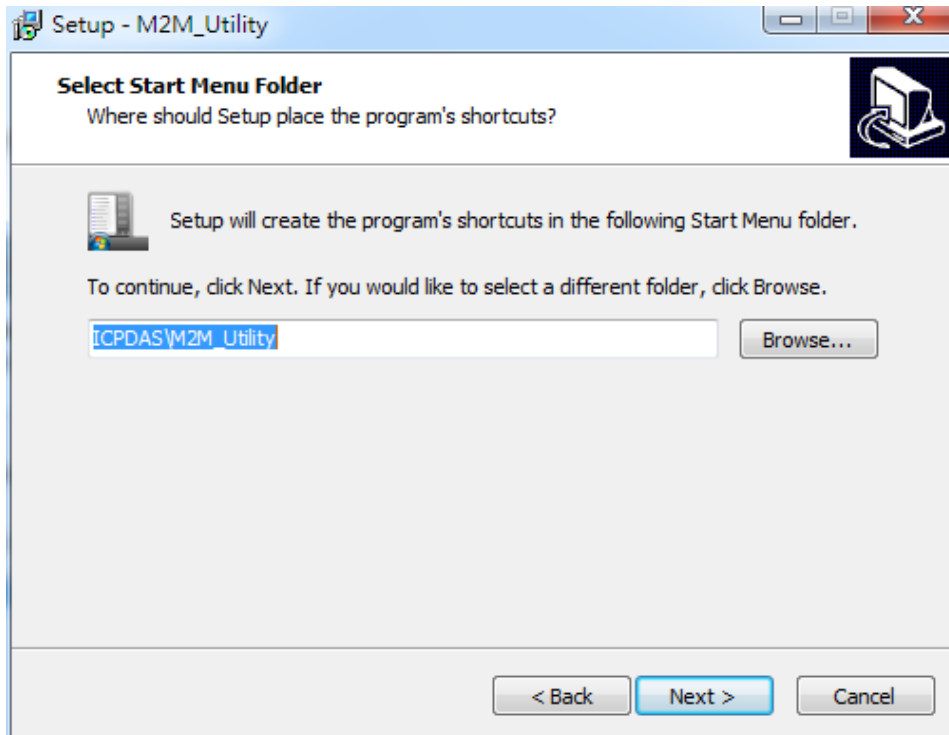

(4) Select whether to establish a shortcut on the desktop. After confirming, press "Next" to continue.

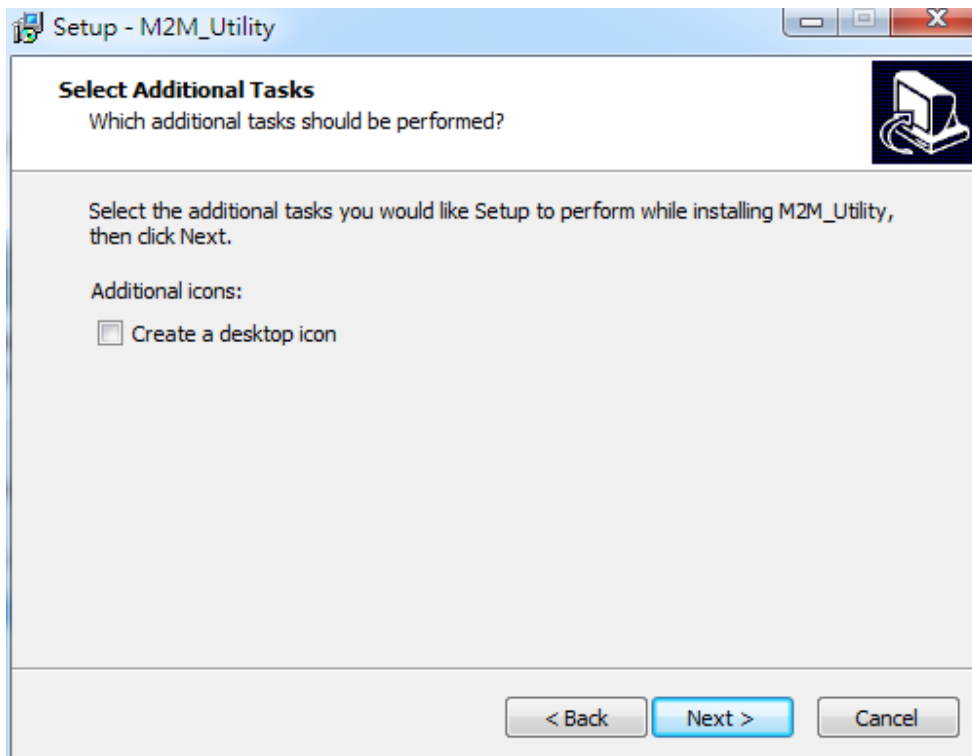

(5) Select "Install" to start the installation.

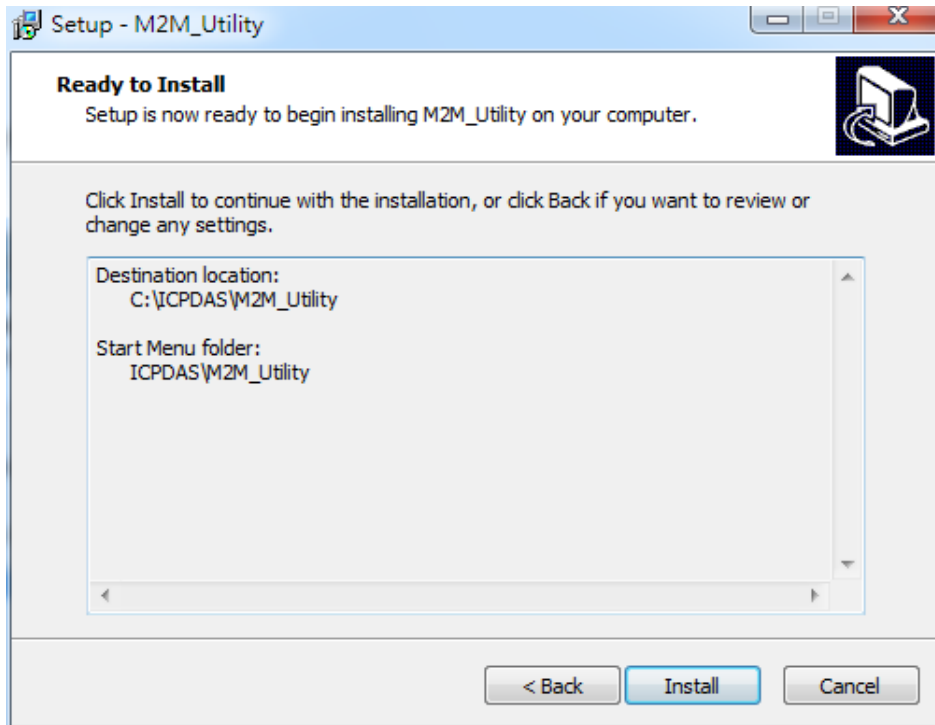

(6) Installation is complete

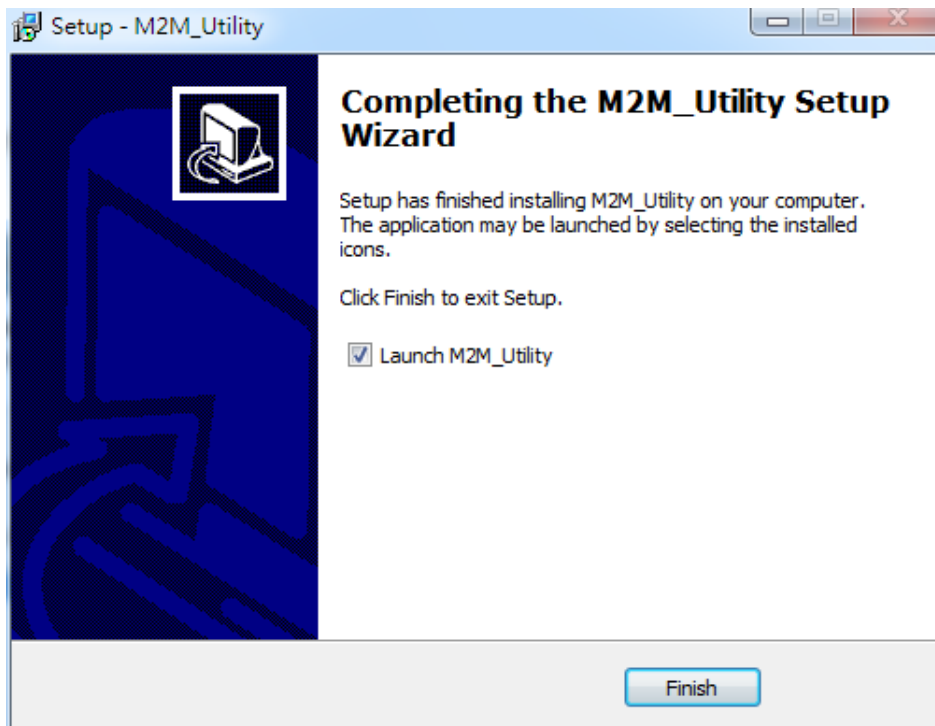

## 4. Turn on the Utility operation instructions

The UTP for each version of the GTP-541M is enabled by M2M\_Utility. The Auto Run-up can be used to detect the internal firmware version of the GTP-541M to enable the utility or manually open the specified Utility from the Manual Run-up.

**Note:** See page 13 to install and execute the M2M Utility.

### 一、Confirmation before opening Utility

1. Check if the 4th pin of the GTP-541M is connected to the 5th pin as shown in Figure 4.1.
2. Turn on the GTP-541M power supply and confirm that the STA light flashes normally before you can start operating M2M Utility.exe.

COM Port and Power Input		
Pin		Description
Frame Ground	1	F.G
Power Input : +10V <sub>DC</sub> ~ +30V <sub>DC</sub>	2	P.GND
	3	PWR
Init.	4	GND
	5	Init.
COM 1 RS-485	6	D-
	7	D+
COM 1 Utility Port RS-232	8	GND
	9	RxD
	10	TxD

Figure 4.1

### 二、The introduction of the layout

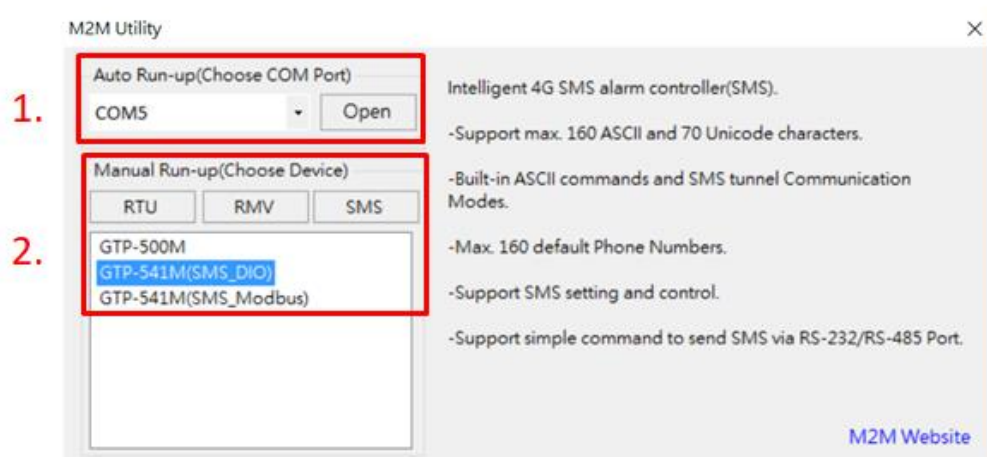

1. Auto Run-up:

Selecting the ComPort number connected to the GTP-541M and pressing Open will automatically determine the Utility corresponding to the current GTP-541M Firmware and enable it.

2. Manual Run-up:

Manually select the Utility version you want to open. Relevant information will be displayed in the right pane when you click the list option. When you double-click the list option, the corresponding Utility will be enabled.

## 4.1 GTP-541M enters the Utility Mode Operating Instructions

Connect the Utility to the GTP-541M by following the steps below:

- A. After connecting the 4th Pin-Gnd of COM Port and Power Input to the 5th Pin-Init, power on the GTP-541M to enter the Utility mode.

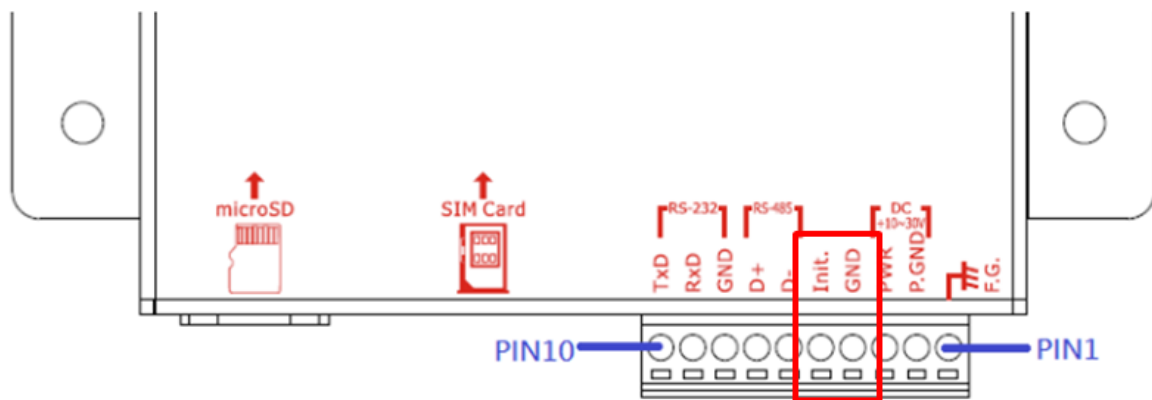

- B. Select the COM Port number corresponding to the RS-232/RS-485 connected to the GTP-541M on the PC side.

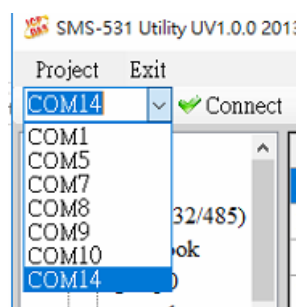

- C. Press the “Connect” button to connect with the GTP-541M. After successful, the “Connect” button will become the “Disconnect” button. If the connection is not successful, check the RS-232/ between the GTP-541M and the PC. Whether the RS-485 line is normal, whether the ComPort is occupied, or whether the 4th Pin-Init is successfully connected to the 5th Pin-Gnd.

## 5. ModBusSMS Utility main screen description

Tool Menu

GTP-541M Modbus SMS Utility V1.0.0 2018/05/15

Project Exit  
COM5 Connect Download Upload Learn System

Parameters	Value	Description
Group Name	group1	1~10 Unicode Char.
Phone 0		
Phone 1		
Phone 2		
Phone 3		
Phone 4		
Phone 5		
Phone 6		
Phone 7		
Phone 8		
Phone 9		
Phone 10		
Phone 11		
Phone 12		
Phone 13		
Phone 14		
Phone 15		

Parameter option

Parameter content

Status column

COM5 115200,n,8,1 COM Port Closed 0



## 5.1 Layout Introduction

### 一、The toolbar



#### ◆ Project:

The parameters are stored in the form of a Project file. This operation includes: "New", "Open", "Save", "Save as..." and so on.

#### ◆ Exit:

Leave the Series Utility.

#### ◆ COM Port:

The COM port number of the PC connected to the GTP-541M.

#### ◆ Connect:

Utility and GTP-541M are connected.

#### ◆ Download:

Download the parameters to the GTP-541M.

#### ◆ Upload:

Upload the parameters of the GTP-541M to the Series Utility.

#### ◆ Learn:

Through this function, users can learn Modbus RTU commands for sending SMS messages and receiving SMS messages, and can test and send SMS messages.

#### ◆ System:

Perform some systemic functional operations, including: "Signal Quality", "Reboot GTP-541M", "Recover Default Settings", "Firmware Version".

### 一、The parameter options

- ◆ GTP-541M's parameter options are divided into 4 categories, including: "System", "COM Port", "Phone Book" and "Alarm Message".

### 二、The parameter content

- ◆ Display details of the change parameters

### 三、The status column

- ◆ Display information about the GTP-541M Series Utility during operation, from left to right, in order:
  1. PC side COM Port number used by Utility
  2. COM Port transmission settings
  3. Current state of COM Port
  4. Current device's Modbus Address
  5. Tips for the results of each operation

## 5.2 Parameter File Management

The Project option can be used to save parameters into files or open parameter files. It is convenient to manage multiple GTP-541M parameters. The options are as follows:

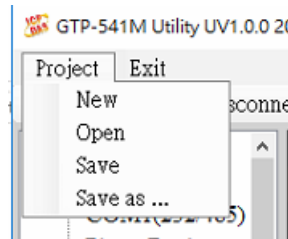

**A. New :**

Create and open a new parameter file.

**B. Open :**

Open an existing parameter file.

**C. Save :**

This function can be used to store parameter files, if the parameters are changed or if the uploaded GTP-541M parameters are to be saved.

**D. Save as :**

Save the parameters as another file name.

## 5.3 Description of parameter options

Click on the left window, the tree parameter option, the right side will display the parameter content in the parameter option, select the content you want to change, then press the right mouse button to modify it, as shown below:

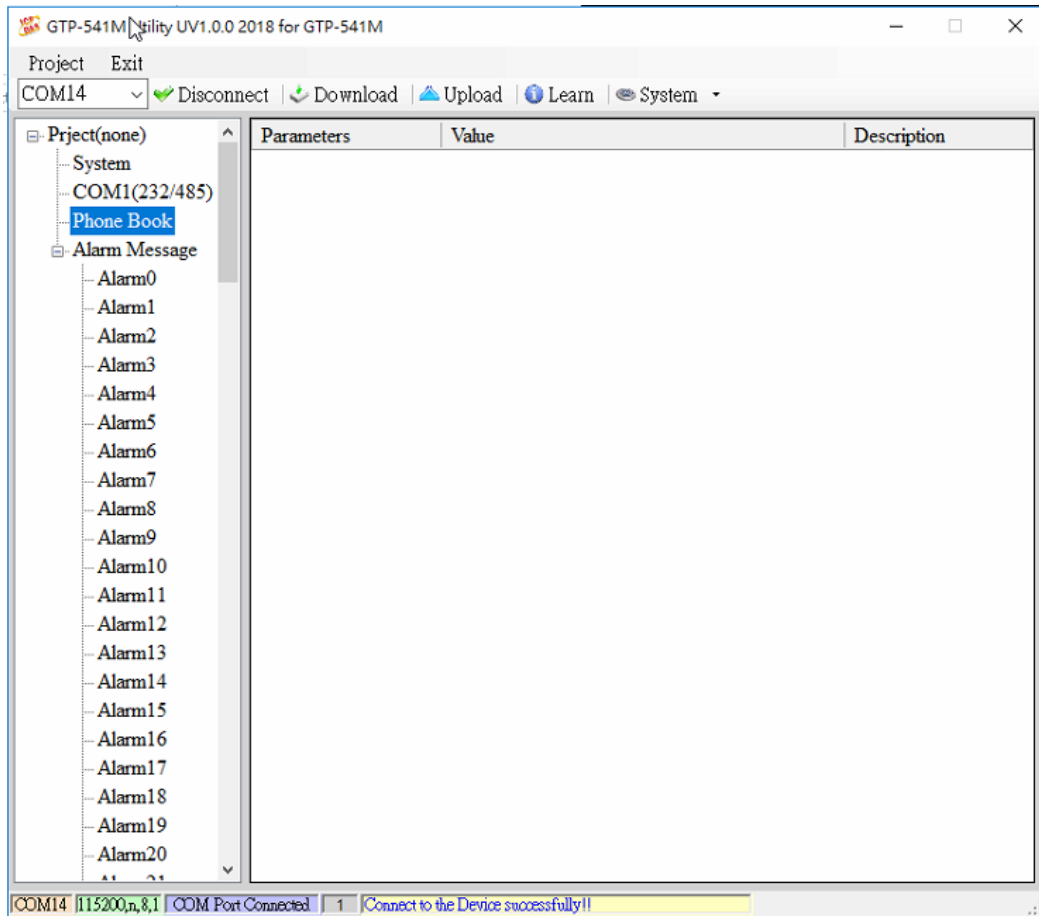

### 5.3.1 Description of System Parameters

The "System" parameters, including 6 items, are:

Parameters	Value	Description
Protocol	Modbus RTU	Read Only
Modbus Address	1	1~247
SMS Check Number	Disable	Enable or Disable
Variable SMS	Disable	Enable or Disable
PIN Code	0000	4 numbers

**A. Protocol:**

The communication protocol supported by the GTP-541M currently supports only Modbus RTU (read only, not changeable).

**B. Module Address:**

Used to set or display the Modbus Address of the GTP-541M.

**C. SMS Check Number:**

Whether the check code is carried at the end of the SMS.

**D. Variable SMS:**

Whether to enable the function of the variable SMS. When this feature is turned on, the content of the transmitted SMS is a combination of the SMS content defined in the Alarm Message and the variable SMS content. Among them, Alarm Message has a maximum of 54 characters, and variable SMS has a maximum of 16 characters, which is a total of 70 characters.

**E. PIN Code:**

The PIN code required to unlock the SIM card.

**5.3.2 COM Port Parameter Description**

"COM Port" parameters, Uart connection ComPort related settings, RS-232 and RS-485 can only be used together can not coexist, the parameters are as follows:

Parameters	Value	Description
Port	COM1 (RS-232/485)	Read Only
Data Bit	8	Only Support 8 bits
Stop Bit	1	1 or 2
Parity Bit	none	none,odd,even
Baudrate	115200	bps

parameter name	Description
Port	COM Port name. Read only, cannot be changed
Data Bit	Data bit, only supports 8 bits
Stop Bit	Stop bit, support 1 and 2 bits
Parity Bit	Peer check, support for none, even and odd
Baudrate	Transmit bits per second, supporting 2400, 4800, 9600, 19200, 38400, 57600 and 115200bps

### 5.3.3 Phone Book Parameter Description

The "Phone Book" parameter is used to define the phone group number and the phone number in the category group. The description is as follows:

#### A. Add a group and edit the group name :

Right click on the "Phone Book" and select "Add Group" to add a new phone group. Up to 16 groups (group0~15) can be supported, as shown below :

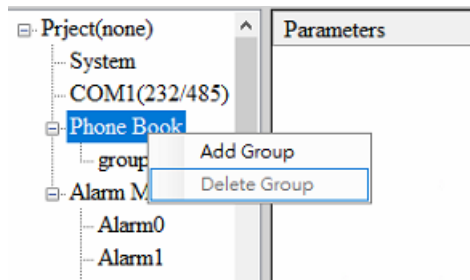

#### B. Modify the group name :

After adding a phone group, to change the group name, first click on the group name in the left window, then go to the right window (Group Name) to change, as shown below :

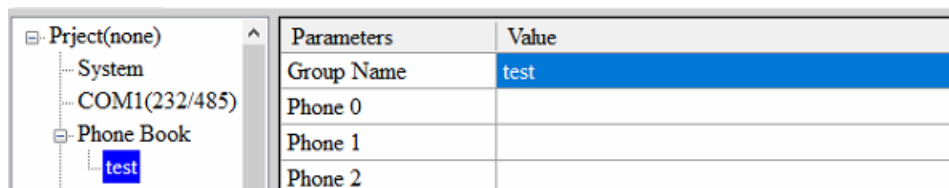

#### C. Delete group :

Click on the phone group you want to delete, right click on it and click on "Delete Group", the phone group will be deleted, as shown below :

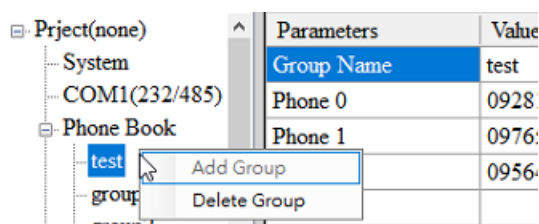

#### D. Add, edit, or delete phone numbers in the group:

Click on the group name in the left window, then add, modify or delete the phone number in the right window. Each group can set up to 16 phone numbers.

Project(none)	Parameters	Value
System	Group Name	test
COM1(232/485)	Phone 0	0928123456
Phone Book	Phone 1	0976543210
test	Phone 2	0956478912
group1	Phone 3	
group2	Phone 4	
Alarm Message	Phone 5	

### 5.3.4 Alarm Message Parameter Description

"Alarm Message" parameters, used to define the content of the SMS and send the target phone group, etc :

Project(none)	Parameters	Value	Description
System	Alarm Channel	0	Read Only
COM1(232/485)	On Message	Channel0 ON	54 Unicode Char.
Phone Book	Off Message	Channel0 OFF	54 Unicode Char.
Alarm Message	SMS Alarm	Enable	Enable or Disable
Alarm0	All Group	<input type="checkbox"/>	
Alarm1	test	<input checked="" type="checkbox"/>	
Alarm2	group1	<input type="checkbox"/>	
Alarm3	group2	<input type="checkbox"/>	
Alarm4	group0	<input checked="" type="checkbox"/>	
Alarm5	group3	<input type="checkbox"/>	
Alarm6	group4	<input type="checkbox"/>	
Alarm7	group5	<input type="checkbox"/>	
Alarm8	group6	<input checked="" type="checkbox"/>	
Alarm9	group7	<input type="checkbox"/>	
Alarm10	group8	<input type="checkbox"/>	
Alarm11	group9	<input type="checkbox"/>	
Alarm12	group10	<input checked="" type="checkbox"/>	
Alarm13	group11	<input type="checkbox"/>	
Alarm14	group12	<input type="checkbox"/>	
Alarm15	group13	<input type="checkbox"/>	
Alarm16	group14	<input checked="" type="checkbox"/>	
Alarm17			
Alarm18			
Alarm19			
Alarm20			

Parameter name	Description
<b>Alarm Channel</b>	<b>Alarm number</b>
<b>On Message</b>	<b>SMS content sent when the alert status is set to On</b>
<b>Off Message</b>	<b>The content of the sent message when the alarm status is set to Off</b>
<b>SMS Alarm</b>	<b>Whether the SMS alert function is enabled</b>
<b>All Group</b>	<b>Check or cancel all phone groups</b>
<b>group0~group15</b>	<b>When checked, when an alarm is triggered, an alert message is sent to the phone number of the checked group.</b>



## 5.4 Download and upload parameters

### A. Download:

After the parameter setting is completed, you can use this button to download the parameters to the GTP-541M Device, as shown below, click the “Download” button.

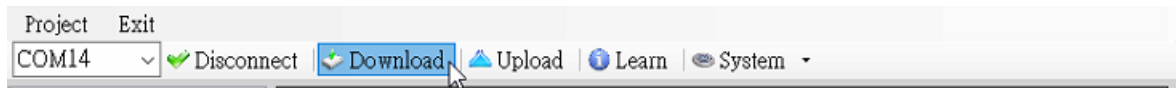

### B. Upload:

When you need to read out the parameters in GTP-541M, you can use this button to read related data from GTP-541M Device, as shown below, click the “Upload” button.



## 5.5 Learning Modbus RTU Commands and Testing

After clicking the “Learn” button, you can enter the Modbus RTU command learning and SMS test and test page. Its main function is to provide users with a quick interface to learn how to send and receive SMS and test through Modbus RTU commands, as shown in the figure below :

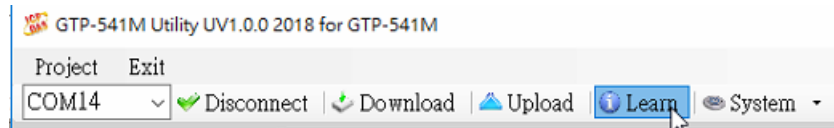

This learning page can be divided into two functions: sending a newsletter and receiving a newsletter :

### A. Sending a newsletter :

Modbus RTU commands that can be used to learn to send text messages, including :

#### 1. Send fixed newsletter content:

Send the SMS according to the content of the SMS and the phone group set in “Alarm Message”. Note: The option in “System->Variable SMS” must be set to Disable.

#### 2. Set variable SMS content and send SMS :

This action will send 2 Modbus RTU commands

- (1) Change variable SMS content (Unicode)
- (2) Sending a newsletter

The content of the newsletter is a combination of the content of the newsletter and the content of the variable newsletter set in the "Alarm Message", and the message transmission method is the same as "transmitting the fixed message content".

**Note: The option in "System->Variable SMS" must be set to Enable**

#### 3. Send a dynamic newsletter:

This action will transfer 3 Modbus RTU commands :

- (1) Change the dynamic phone number (ASCII code)
- (2) Change dynamic SMS content (Unicode code)
- (3) Send a dynamic newsletter

**Note: To send a dynamic message, you must wait for the previous message to be sent before you can transfer the next message.**

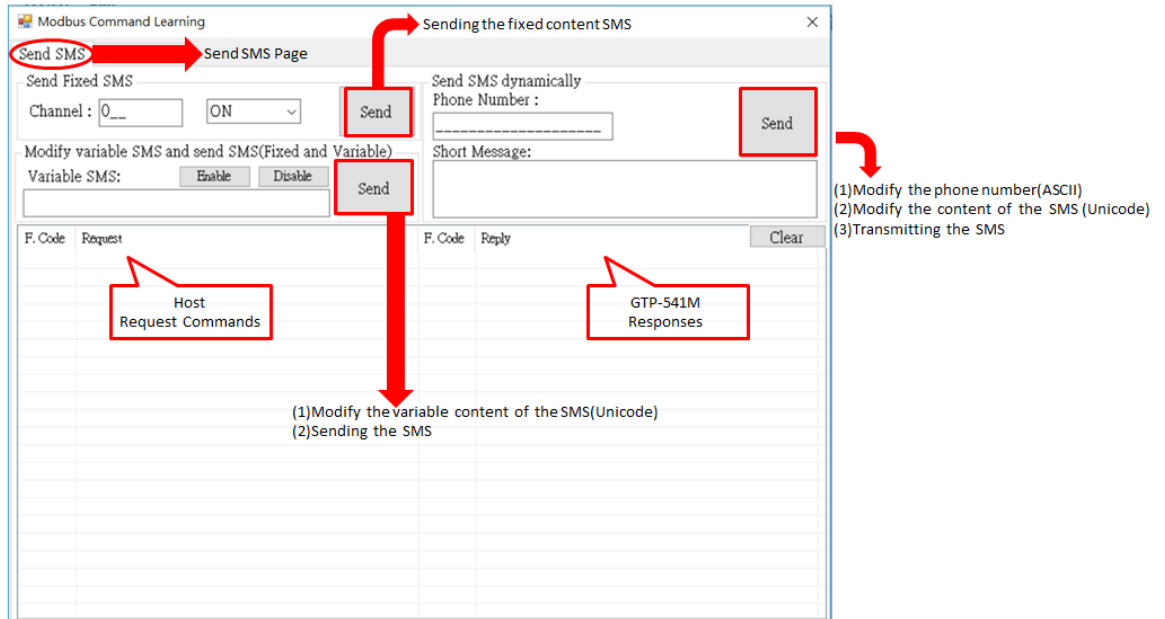

### B. Receiving newsletters :

This page is mainly for users to learn how to receive SMS from GTP-541M. The receiving SMS function of GTP-541M has a filtering design that can be set to be turn on or off. Only the SMS sent by the phone in the phone group will be received and stored by GTP-541M. The steps for receiving the newsletter are as follows :

1. After pressing the “Start” button, the GTP-541M Series Utility will send a Modbus RTU command every 20 seconds to ask if the GTP-541M has received the SMS.
2. If yes, send 3 Modbus RTU commands to read the received SMS content :
  - (1) Date of receipt of the newsletter
  - (2) Send a text message for the newsletter
  - (3) Newsletter content
3. Finally, send a Modbus RTU command to clear the SMS message, so that you can continue to receive the next SMS.

Receive SMS Page

Modbus Command Learning

Send SMS Receive SMS

Learn to Receive SMS

Scan Time(sec): 5\_

Is SMS Received: NO

Start Stop

NO. Date Phone ShortMessage

Clear

Received SMS From GTP-541M

Ask one time Per 5 second

F. Code Request F. Code Reply

Clear

Host Request command

GTP-541M Responded

Start or Stop to Ask the GTP-541M whether Is receiving the new SMS

## 5.6 System function

### 5.6.1 Querying the signal strength of the module

Click “System->Signal Quality” to query the current 4G signal strength of GTP-541M.

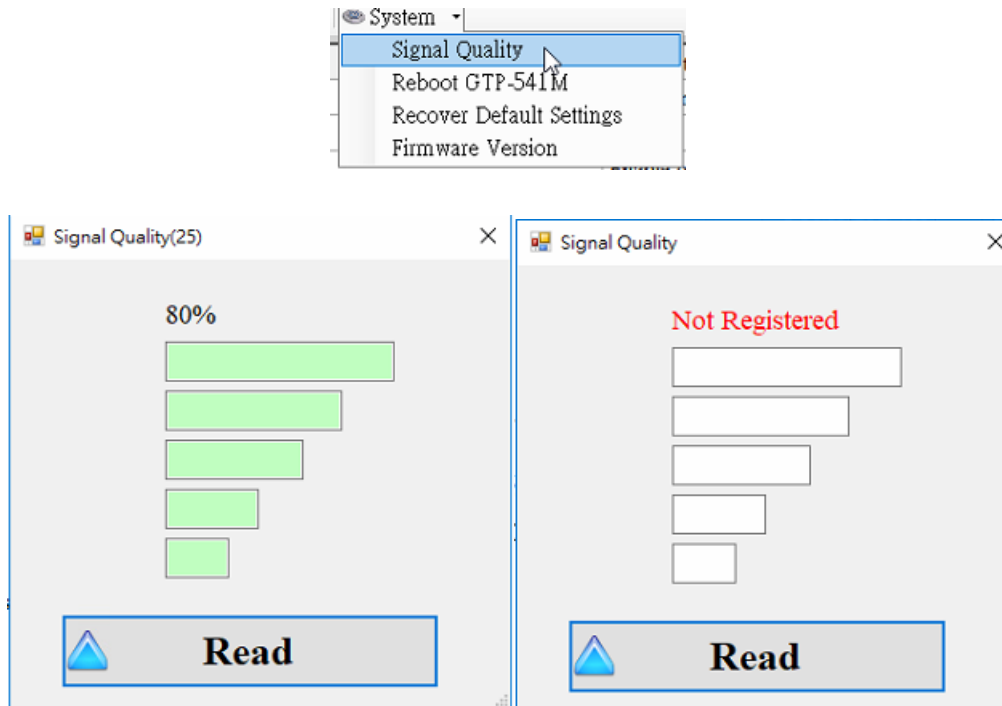

#### A. Field Description :

The signal strength is expressed in 5 segments and shows the current percentage of the signal strength. It will be displayed when there is no signal "Not Registered" .

#### B. Description of operation options :

Read: Read the current 4G signal strength from GTP-541M.

### 5.6.2 Querying the Firmware Version

Click “System->Firmware Version” to display the version of the Utility and the version information of the firmware. The description is as follows :

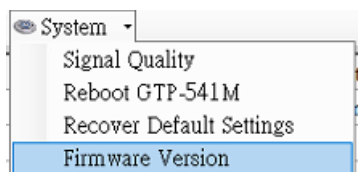

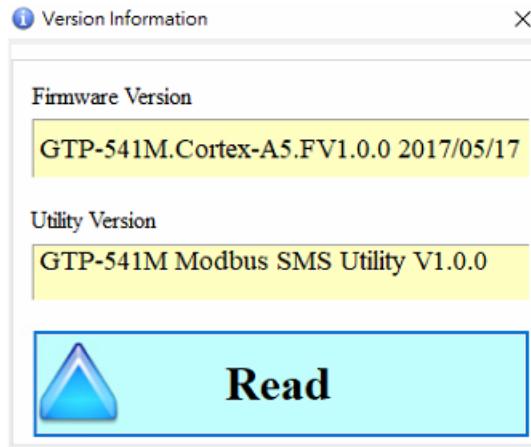

**A. Field Description :**

- (1) Firmware Version: Display firmware version information
- (2) Utility Version: Display version information of GTP-541M Series Utility

**B. Description of operation options :**

- (1) Read: Read the firmware version information from GTP-541M and display it in the window.

### 5.6.3 Restarting GTP-541M

Click "System->Reboot GTP-541M" to restart GTP-541M

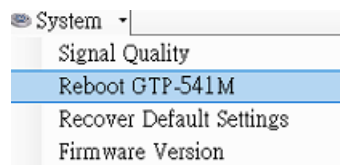

### 5.6.4 Reply to factory defaults

Click "System->Recover Default Settings" to return the parameters to the factory defaults.

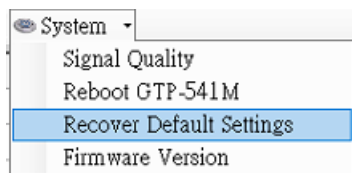

### 5.6.5 Voice file format and status

- (1) Please add a voice folder to the SD card first, and then put the voice file into the voice folder.

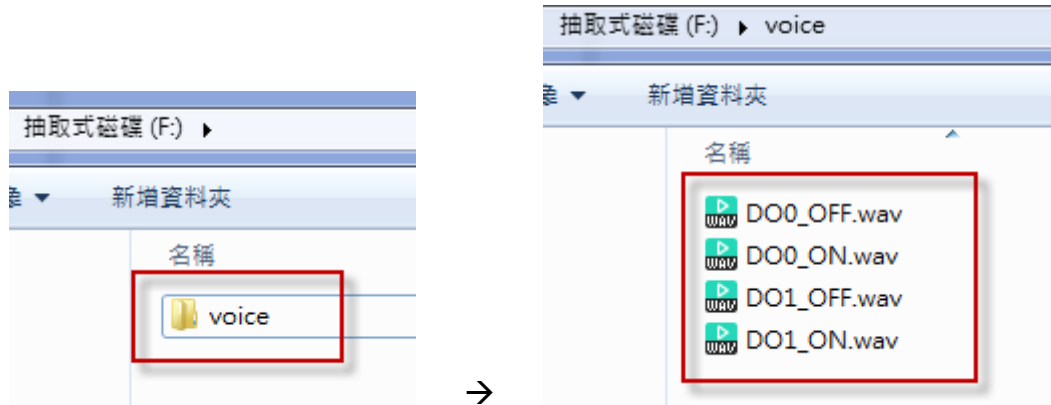

- (2) Click “System->Voice File Status” on the Utility to check whether the current voice file status and format in the SD card match.

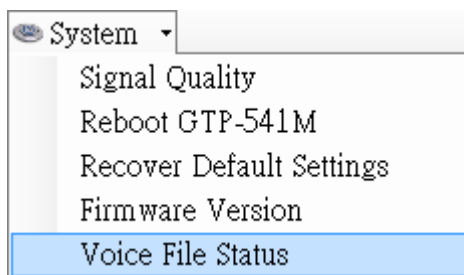

The Voice File Status page can view the voice files of the ON and OFF states corresponding to each Alarm. If the file exists, the Existed item will display a tick, and the File Format Status item displays whether the current voice file format meets the voice dialing requirements. Correct will display a green background, if not, it will display Incorrect!! with a red background. Once the system detects that the voice file format does not meet the playback requirements, even if the Alarm is triggered, the voice alarm will not be activated. Please correct the voice file format to meet the playback requirements.

Channel	Value	Existed	File at Device	File Format Status
Alarm0	ON	<input checked="" type="checkbox"/>	DO0_ON.WAV	Correct.
	OFF	<input checked="" type="checkbox"/>	DO0_OFF.WAV	Correct.
Alarm1	ON	<input checked="" type="checkbox"/>	DO1_ON.WAV	Correct.
	OFF	<input checked="" type="checkbox"/>	DO1_OFF.WAV	Incorrect!!
Alarm2	ON	<input type="checkbox"/>	DO2_ON.WAV	No wav File.
	OFF	<input type="checkbox"/>	DO2_OFF.WAV	No wav File.
Alarm3	ON	<input type="checkbox"/>	DO3_ON.WAV	No wav File.
	OFF	<input type="checkbox"/>	DO3_OFF.WAV	No wav File.
Alarm4	ON	<input checked="" type="checkbox"/>	DO4_ON.WAV	Incorrect!!
	OFF	<input type="checkbox"/>	DO4_OFF.WAV	No wav File.
Alarm5	ON	<input type="checkbox"/>	DO5_ON.WAV	No wav File.
	OFF	<input type="checkbox"/>	DO5_OFF.WAV	No wav File.

SD Card OK There are 3 wav file's format that are incorrect. Please correct them immediately!!

### (3) Voice File Format

The GTP-541M only supports the playback of WAV files. The following formats are required. For example, if the voice file is not in the following format, please use the software to convert:

File type	wav
Audio format	PCM
Audio sample size	16 bits
Channel	mono
Audio sampling frequency	8 kHz
Audio bit rate	128kbps



## 5.7 Using the sample description

The following are examples of four usage examples, as follows :

Example	Description
Example 1: Sending the general alarm SMS(Level Trigger)	This example shows how to send the fixed content alarm SMS by Modbus commands in Level Trigger mode.
Example 2: Sending the variable alarm SMS	This example shows how to send the variable content alarm SMS by Modbus commands.
Example 3: Sending the alarm SMS dynamically	This example shows how to send the alarm SMS to the specific phone dynamically by Modbus commands.
Example4: Receiving the SMS	This example shows how to receive SMS from the GTP-541M by Modbus commands.
Example 5: Sending the general alarm SMS (Edge Trigger)	This example shows how to send the voice alarm by Modbus commands.
Example 6: Sending the alarm voice	This example shows how to send the voice alarm by Modbus commands.

### 5.7.1 Example 1: Sending the general alarm SMS (Level Trigger)

This example illustrates the action that should be taken to transfer a fixed message content to a defined phone number.

#### 1. Set parameters through the GTP-541M Series Utility

(1) Connect to GTP-541M, the Alarm Mode field will enable

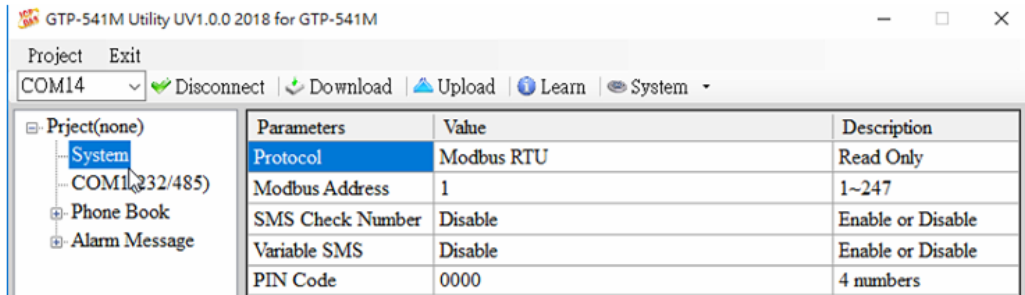

(2) Add a new project named File1.prj

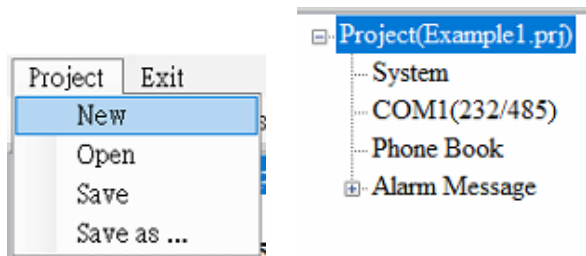

(3) Set the Modbus Address of GTP-541M, the factory default is 1

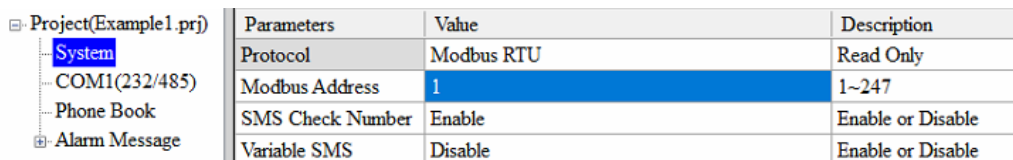

(4) Add 2 phone groups and add a phone number as shown below :

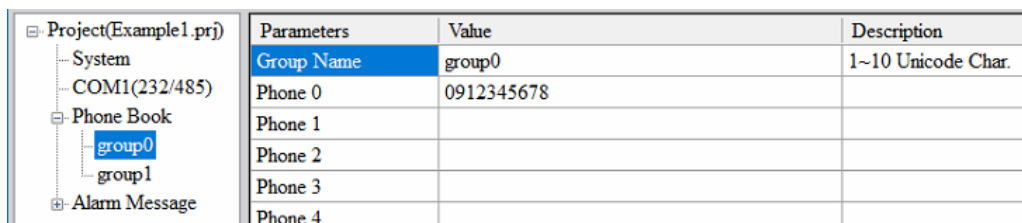

Parameters	Value	Description
Group Name	group1	1~10 Unicode Char.
Phone 0	0987654321	
Phone 1		
Phone 2		
Phone 3		
Phone 4		

(5) Set Alarm Channel 0 and Alarm Channel1 respectively, as follows :

Parameters	Value	Description
Alarm Channel	0	Read Only
On Message	Channel0 ON	54 Unicode Char.
Off Message	Channel0 OFF	54 Unicode Char.
SMS Alarm	Enable	Enable or Disable
All Group	<input type="checkbox"/>	
group0	<input checked="" type="checkbox"/>	
group1	<input type="checkbox"/>	

Parameters	Value	Description
Alarm Channel	1	Read Only
On Message	Channel1 ON	54 Unicode Char.
Off Message	Channel1 OFF	54 Unicode Char.
SMS Alarm	Enable	Enable or Disable
All Group	<input type="checkbox"/>	
group0	<input type="checkbox"/>	
group1	<input checked="" type="checkbox"/>	

(6) Connect GTP-541M and download the parameters to GTP-541M



## 2. Modbus RTU command

(1) The control host connects to the GTP-541M COM1 (RS-232/RS-485) via RS-232 or RS-485.



(2) The control host sends a Modbus RTU command to the GTP-541M to send a text message.

Command and action description :

command	Send an alert (16-bit)	command	01 05 00 00 FF 00 8C 3A
		Respond	01 05 00 00 FF 00 8C 3A
Action description	After the GTP-541M receives the command, the content of the SMS message is: in Alarm Channel0, the content defined in the "On Message" field is transmitted to whom: the phone number defined in group0		
result	The phone number defined in the phone group group0 should receive the newsletter with the message content "Channel0 ON"		

Command format description :

Send an alert		
command	Byte 0	Modbus Address set by GTP-541M
	Byte 1	Function Code = 0x05
	Byte 2 ~ 3	Alarm Channel
	Byte 4 ~ 5	=0xFF00 Send the newsletter content in the "On Message" field =0x0000 Send the newsletter content in the "Off Message" field
	Byte 6 ~ 7	CRC-16 check code

Correct response	Byte 0	Modbus Address set by GTP-541M
	Byte 1	Function Code = 0x05
	Byte 2 ~ 3	Alarm Channel
	Byte 4 ~ 5	=0xFF00 or =0x0000
	Byte 6 ~ 7	CRC-16 check code

### 5.7.2 Example 2: Variable SMS Alerts

This example is mainly to illustrate the actions that should be taken to transmit variable SMS content to a defined phone number. Among them, the variable SMS content is the combination of the content defined in the Alarm Message (maximum 54 Unicode words), plus the combination of variable SMS content (maximum 16 Unicode words).

#### 1. Set parameters through the GTP-541M Series Utility

(1) Add a new project named File2.prj

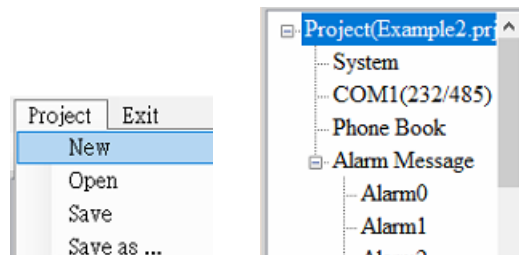

(2) Set the Modbus Address of GTP-541M, the factory default is 1, and set the “Variable SMS” field to Enable.

Parameters	Value	Description
Protocol	Modbus RTU	Read Only
Modbus Address	1	1~247
SMS Check Number	Disable	Enable or Disable
Variable SMS	Enable	Enable or Disable
PIN Code	0000	4 numbers

(3) Add 2 phone groups and add a phone number as shown below :

Parameters	Value	Description
Group Name	group0	1~10 Unicode Char.
Phone 0	0912345678	
Phone 1		
Phone 2		
Phone 3		

Parameters	Value	Description
Group Name	group1	1~10 Unicode Char.
Phone 0	0987654321	
Phone 1		
Phone 2		
Phone 3		

(4) Set Alarm Channel 0 and Alarm Channel1 respectively, as follows :

Parameters	Value	Description
Alarm Channel	0	Read Only
On Message	Channel0 ON	54 Unicode Char.
Off Message	Channel0 OFF	54 Unicode Char.
SMS Alarm	Enable	Enable or Disable
All Group	<input type="checkbox"/>	
group0	<input checked="" type="checkbox"/>	
group1	<input type="checkbox"/>	

Parameters	Value	Description
Alarm Channel	1	Read Only
On Message	Channel1 ON	54 Unicode Char.
Off Message	Channel1 OFF	54 Unicode Char.
SMS Alarm	Enable	Enable or Disable
All Group	<input type="checkbox"/>	
group0	<input type="checkbox"/>	
group1	<input checked="" type="checkbox"/>	

(5) Connect GTP-541M and download the parameters to GTP-541M



## 2.Modbus RTU command

(1) The control host connects to the GTP-541M COM1 (RS-232/RS-485) via RS-232 or RS-485.



(2) The control host sends a Modbus RTU command to the GTP-541M, first sets the variable SMS content, and then transmits the SMS.

Command and action description :

command	Set variable newsletter content	command	01 10 01 7F 00 06 0C 2B 00 56 00 53 00 4D 00 53 00 00 00 E7 DD
		Respond	01 10 01 7F 00 06 70 2F
	Send an alert	command	01 05 00 01 FF 00 DD FA
		Respond	01 05 00 01 FF 00 DD FA
Action description	<ol style="list-style-type: none"> <li>1. First set the variable SMS content as: +VSMS</li> <li>2. Send a message again</li> <li>3. The content of the newsletter is: in the Alarm Channel1, the content defined by the "On Message" field, plus the variable newsletter content.</li> <li>4. To whom: the phone number defined in group1</li> </ol>		
result	The phone number defined in the phone group group1 receives the newsletter and its message content is "Channel1 ON+VSMS".		

Command format description :

Set variable newsletter content		
command	Byte 0	Modbus Address set by GTP-541M
	Byte 1	Function Code = 16
	Byte 2 ~ 3	Data Address, the starting address of the variable SMS content definition
	Byte 4 ~ 5	Register Count, the number of words in the newsletter, up to 16 Unicode characters
	Byte 6	Byte Count (Register Counter x 2), the content of the newsletter accounts for a few Bytes
	Byte7 ~ 18	Byte Count (Register Counter x 2), the content of the newsletter accounts for a few Bytes...
	Byte19 ~ 20	CRC-16 check code
Correct response	Byte 0	Modbus Address set by GTP-541M
	Byte 1	Function Code = 16 (0x10)



	Byte 2 ~ 3	Data Address, the starting address of the variable SMS content definition
	Byte 4 ~ 5	Register Count, the number of words in the newsletter
	Byte 6 ~ 7	CRC-16 check code

Send a newsletter		
command	Byte 0	Modbus Address set by GTP-541M
	Byte 1	Function Code = 0x05
	Byte 2 ~ 3	Alarm Channel
	Byte 4 ~ 5	=0xFF00 Send the newsletter content in the "On Message" field =0x0000 Send the newsletter content in the "Off Message" field
	Byte 6 ~ 7	CRC-16 check code
Correct response	Byte 0	Modbus Address set by GTP-541M
	Byte 1	Function Code = 0x05
	Byte 2 ~ 3	Alarm Channel
	Byte 4 ~ 5	=0xFF00 or =0x0000
	Byte 6 ~ 7	CRC-16 check code

### 5.7.3 Example 3: Dynamic SMS alert

This example is mainly to illustrate the action that should be taken if a dynamic SMS is to be sent to a dynamic phone number. Among them, dynamic newsletter content, support up to 70 Unicode characters to transmit dynamic newsletters, no need to set any parameters through GTP-541M Series Utility, can be directly through the Modbus RTU commands, the examples are as follows :

- (1)The control host connects to the GTP-541M COM1 (RS-232/RS-485) via RS-232 or RS-485.



- (2)The control host pairs the GTP-541M to issue the Modbus RTU command, set the dynamic message content and phone number, and then transmit

Command and action description :

command	Set dynamic phone number (hex)	command	01 10 01 D5 00 06 0C 30 31 32 33 34 35 36 37 38 39 00 00 D5 2B
		Respond	01 10 01 D5 00 06 50 0F
	Set dynamic newsletter content (hexadecimal)	command	01 10 01 8F 00 0C 18 44 00 79 00 6E 00 61 00 6D 00 69 00 63 00 20 00 53 00 4D 00 53 00 00 00 AC 3B
		Respond	01 10 01 8F 00 0C F0 1B
	Send a newsletter (hexadecimal)	command	01 05 00 80 FF 00 8D D2
		Respond	01 05 00 80 FF 00 8D D2
Action description	<ol style="list-style-type: none"> <li>1. Set the phone number to: 0123456789</li> <li>2. Set the content of the newsletter as: Dynamic SMS</li> <li>3. Send a newsletter</li> </ol>		

result	Phone 0123456789, you will receive a newsletter with the following message: Dynamic SMS
--------	---

Format description :

Set a dynamic phone number		
command	Byte 0	Modbus Address set by GTP-541M
	Byte 1	Function Code = 16 (0x10)
	Byte 2 ~ 3	Data Address, the starting address of the dynamic phone number
	Byte 4 ~ 5	Register Count, the number of Registers in the phone number
	Byte 6	Byte Count (Register Counter x 2), the length of the phone number
	Byte7 ~ 18	Phone number, ASCII code, at least one 00 is the end character. If the phone number is 20, the end character is not required.
	Byte19 ~ 20	CRC-16 check code
Correct response	Byte 0	Modbus Address set by GTP-541M
	Byte 1	Function Code = 16 (0x10)
	Byte 2 ~ 3	Data Address, the starting address of the dynamic phone number
	Byte 4 ~ 5	Register Count, the number of Registers in the phone number
	Byte 6 ~ 7	CRC-16 check code

Set dynamic newsletter content		
command	Byte 0	Modbus Address set by GTP-541M
	Byte 1	Function Code = 16 (0x10)
	Byte 2 ~ 3	Data Address, the starting address defined by the dynamic message
	Byte 4 ~ 5	Register Count, the number of words in the dynamic newsletter, up to 70 Unicode characters
	Byte 6	Byte Count(Register Counter x 2)
	Byte7 ~ 30	Dynamic newsletter, Unicode code, ending with 0x0000 characters, if the length is 70 characters, no end character is required
	Byte 31 ~ 32	CRC-16 check code
Correct response	Byte 0	Modbus Address set by GTP-541M
	Byte 1	Function Code = 16 (0x10)
	Byte 2 ~ 3	Data Address, the starting address defined by the dynamic message
	Byte 4 ~ 5	Register Count, the number of words in the dynamic newsletter
	Byte 6 ~ 7	CRC-16 check code

Send a newsletter		
command	Byte 0	Modbus Address set by GTP-541M
	Byte 1	Function Code = 0x05
	Byte 2 ~ 3	= 0x0080
	Byte 4 ~ 5	= 0xFF00
	Byte 6 ~ 7	CRC-16 check code
Correct response	Byte 0	Modbus Address set by GTP-541M
	Byte 1	Function Code = 0x05
	Byte 2 ~ 3	= 0x0080
	Byte 4 ~ 5	= 0xFF00
	Byte 6 ~ 7	CRC-16 check code

### 5.7.4 Example 4: Receiving a newsletter

This example is mainly to explain how to read the newsletter content received by GTP-541M.

1. Set parameters through the GTP-541M Series Utility

(1) Add a new project named File4.prj

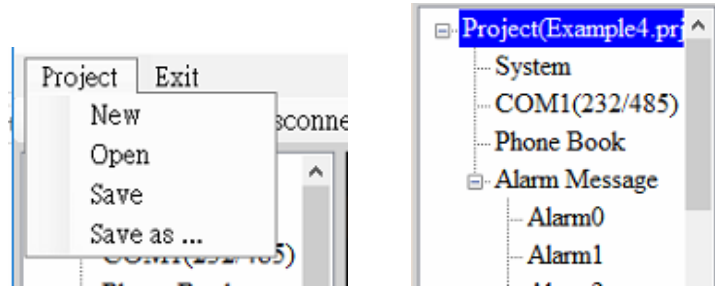

(2) Set the Modbus Address of the GTP-541M, the factory default is 1. Receive Simplified function If you need to limit the phone number, Receive SMS Filter selects Edable

<ul style="list-style-type: none"> <li>Project(none)</li> <li>System</li> <li>COM1(232/485)</li> <li>Phone Book</li> <li>group0</li> <li>Alarm Message</li> </ul>	Parameters	Value	Description
	Protocol	Modbus RTU	Read Only
	Modbus Address	1	1~247
	Variable SMS	Disable	Enable or Disable
	Alarm Mode	Level Trigger	Level or Edge Trigger
	PIN Code	0000	4 numbers
	Recieve SMS Filter	Enable	Enable or Disable

(3) Add 1 phone group and add a phone number as shown below. GTP-541M if you turn on phone filtering, only the phone number in the phone group will be sent.

<ul style="list-style-type: none"> <li>Project(Example4.prj)</li> <li>System</li> <li>COM1(232/485)</li> <li>Phone Book</li> <li>group0</li> <li>Alarm Message</li> </ul>	Parameters	Value	Description
	Group Name	group0	1~10 Unicode Char.
	Phone 0	0987654321	
	Phone 1		
	Phone 2		

(4) Connect GTP-541M and download the parameters to GTP-541M



## 2. Modbus RTU command

- (1) The control host connects to the GTP-541M COM1 (RS-232/RS-485) via RS-232 or RS-485.



- (2) The control host sends a Modbus RTU command to the GTP-541M to poll the GTP-541M for receiving the SMS. If so, read the SMS content.

Command and action description :

command	Check if there is a newsletter (hexadecimal)	command	01 02 00 01 00 01 E8 0A
		Respond	01 02 01 00 A1 88 (no newsletter received) 01 02 01 01 60 48 (received newsletter)
	Read transmitter	command	01 04 00 1E 00 0A 10 0B

	phone (hexadecimal)	Respond	01 04 14 38 38 36 39 32 38 37 36 36 35 30 37 00 00 00 00 00 00 00 00 B6 6E
	Read receipt date (hexadecimal)	command	01 04 00 28 00 07 31 C0
		Respond	01 04 0E 32 30 31 38 30 38 30 32 30 39 35 35 33 31 3D 79
	Read newsletter content (hexadecimal)	command	01 04 00 2F 00 51 00 3F
		Respond	1 4 A2 00 00 48 65 6C 6C 6F 2C 47 54 50 2D 35 34 31 21 00 00 00 .....(data total 162 Bytes)
Action description	Send the newsletter to the GTP-541M with the phone number in the phone group. The content is "Hello, GTP-541!". Polling, continuously check whether the GTP-541M receives the newsletter and if it receives the newsletter. The commands for reading the sender's phone, the date of receipt, and the content of the message are sent continuously because the sender's phone, the date of receipt, and the address of the message are contiguous. Therefore, all the information can be read back using only one read command.		
result	The result of reading is: Transmitter's phone: 886928766507 Received date: 20180802095531 (2018/08/02/ 09:55:31) Newsletter content: Hello, GTP-541M!		

Format description :

Check if there is a newsletter		
command	Byte 0	Modbus Address set by GTP-541M
	Byte 1	Function Code = 2
	Byte 2 ~ 3	Data Address, whether the indication address of the SMS has been received
	Byte 4 ~ 5	Bit Count , 1 bit

	Byte 6 ~ 7	CRC-16 check code
Correct response	Byte 0	Modbus Address set by GTP-541M
	Byte 1	Function Code = 2
	Byte 2	Byte Count, data accounted for a few Bytes
	Byte 3	= 0, no newsletter received = 1, I received a newsletter
	Byte 4 ~ 5	CRC-16 check code

Read transmitter phone		
command	Byte 0	Modbus Address set by GTP-541M
	Byte 1	Function Code = 4
	Byte 2 ~ 3	Data Address, the starting address of the sender's phone
	Byte 4 ~ 5	Data Address, the starting address of the sender's phone...
	Byte 6 ~ 7	CRC-16 check code
Correct response	Byte 0	Modbus Address set by GTP-541M
	Byte 1	Function Code = 4
	Byte 2	Byte Count, data accounted for a few Bytes
	Byte 3 ~ 22	Transmitter phone number, ASCII code, ending with 0x00
	Byte 23 ~ 24	CRC-16 check code

Read receipt date		
command	Byte 0	Modbus Address set by GTP-541M
	Byte 1	Function Code = 4
	Byte 2 ~ 3	Modbus Address set by GTP-541M...
	Byte 4 ~ 5	Register Count, read several Register data, fixed at 7 (0x07)
	Byte 6 ~ 7	CRC-16 check code
Correct response	Byte 0	Modbus Address set by GTP-541M
	Byte 1	Function Code = 4



	Byte 2	Byte Count, data accounted for a few Bytes
	Byte 3 ~ 22	Byte Count, data accounted for a few Bytes...
	Byte 23 ~ 24	CRC-16 check code

Read newsletter content		
command	Byte 0	Modbus Address set by GTP-541M
	Byte 1	Function Code = 4
	Byte 2 ~ 3	Data Address, the starting address of the content of the stored newsletter
	Byte 4 ~ 5	Register Count, read several Register data, fixed at 81 (0x51)
	Byte 6 ~ 7	CRC-16 check code
Correct response	Byte 0	Modbus Address set by GTP-541M
	Byte 1	Function Code = 4
	Byte 2	Byte Count, data accounted for a few Bytes
	Byte 3 ~ 22	=0x0000, the content of the newsletter is ASCII code =0x0001, the content of the newsletter is Unicode code
	Byte 23 ~ 24	CRC-16 check code

### 5.7.5 Example 5: Sending the general alarm SMS (Edge Trigger)

This example shows the steps to send the defined SMS to the defined phones in Edge Trigger mode.

#### 1. Setting the parameters by the GTP-541M Series Utility

(1) Connect to the GTP-541M. The Alarm Mode field will be enabled.

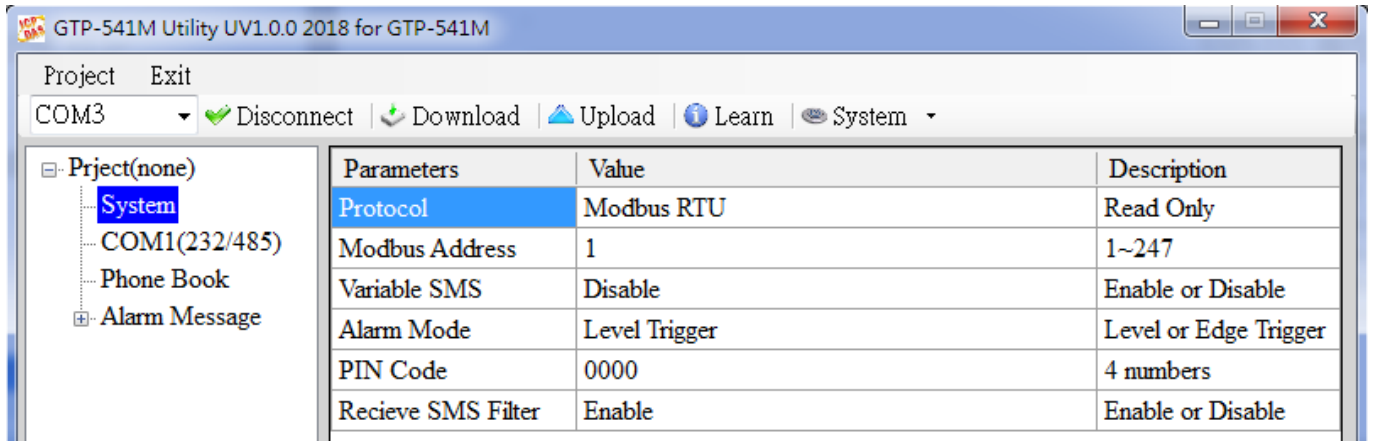

(2) Choose the edge trigger mode.

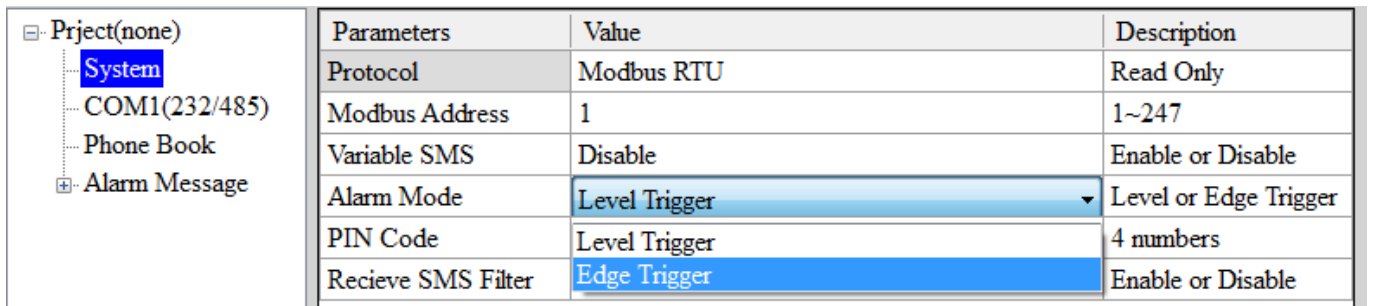

(3) New and name an “Example5.prj” project in the Utility.

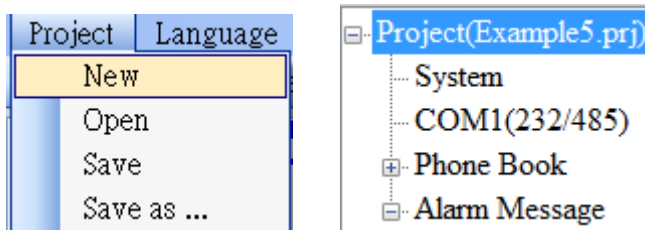

(4) Set the modbus address as 1. (The factory default address is 1)

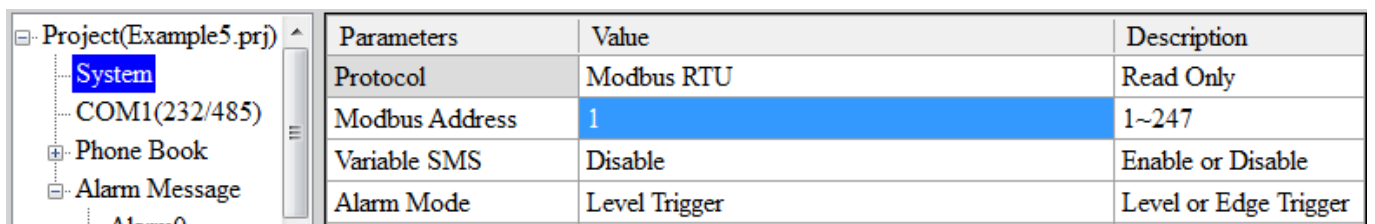

(5) Add 2 new phone groups and input phone numbers as follows:

Parameters	Value	Description
Group Name	group0	1~10 Unicode Char.
Phone 0	0123456789	
Phone 1		
Phone 2		

Parameters	Value	Description
Group Name	group1	1~10 Unicode Char.
Phone 0	123456789	
Phone 1		
Phone 2		
Phone 3		

(6) Set the Alarm Channel0 and Channel1 separately as follows:

Parameters	Value	Description
Alarm Channel	0	Read Only
On Message	Channel0 ON	54 Unicode Char.
Off Message	Channel0 OFF	54 Unicode Char.
SMS Alarm	Enable	Enable or Disable
Voice Alarm	Disable	Enable or Disable
Trigger Time	10	0~9999 Secs
All Group	<input type="checkbox"/>	
group0	<input checked="" type="checkbox"/>	
group1	<input type="checkbox"/>	

Parameters	Value	Description
Alarm Channel	1	Read Only
On Message	Channel1 ON	54 Unicode Char.
Off Message	Channel1 OFF	54 Unicode Char.
SMS Alarm	Enable	Enable or Disable
Voice Alarm	Disable	Enable or Disable
Trigger Time	20	0~9999 Secs
All Group	<input type="checkbox"/>	
group0	<input type="checkbox"/>	
group1	<input checked="" type="checkbox"/>	

(7) Connect to the GTP-541M and download these parameters to it.

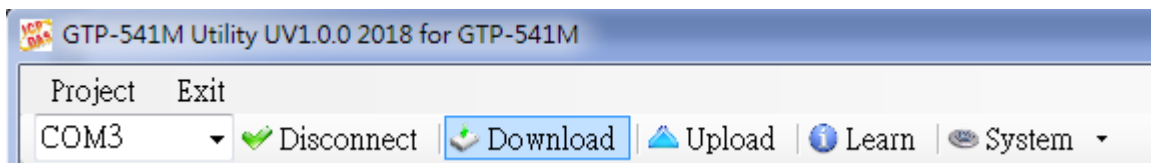

## 2. Modbus RTU commands

(1) Connect COM1 (RS-232/RS-485) of the GTP-541M to the Host.



(2) Sending the Modbus commands from the Host to the GTP-541M to transmit the alarm SMS as follows:

Commands and Description:

Command s	Sending Alarm SMS (Hex)	Comman d	01 05 00 00 FF 00 8C 3A
		Respons e	01 05 00 00 FF 00 8C 3A
Descriptio n	<p>1. The GTP-541M receives the Modbus command then sends the alarm message.</p> <p>2. The content of the alarm SMS is "On Message" of Alarm Channel0 message.</p> <p>3. The alarm SMS would send to the defined phone groups.</p>		
Result	<p>The phones defined in the group0 would receive the SMS after 10 seconds. The content of the SMS is "Channel0 ON"</p>		

## Command Format:

Send the alarm SMS		
Command	Byte 0	The Modbus Address of the GTP-541M
	Byte 1	Function Code = 0x05
	Byte 2 ~ 3	Alarm Channel
	Byte 4 ~ 5	=0xFF00, Sending the field content of "On Message". =0x0000, Sending the field content of "Off Message".
	Byte 6 ~ 7	CRC-16
Correct Response	Byte 0	The Modbus Address of the GTP-541M
	Byte 1	Function Code = 0x05
	Byte 2 ~ 3	Alarm Channel
	Byte 4 ~ 5	=0xFF00 or =0x0000
	Byte 6 ~ 7	CRC-16

### 5.7.6 Example 6: Sending the alarm voice

This example is shown how to send the defined voice alarm via the GTP-541M.

#### 1. Setting the parameters by the GTP-541M Series Utility

(1) New and name an “Example6.prj” project in the Utility.

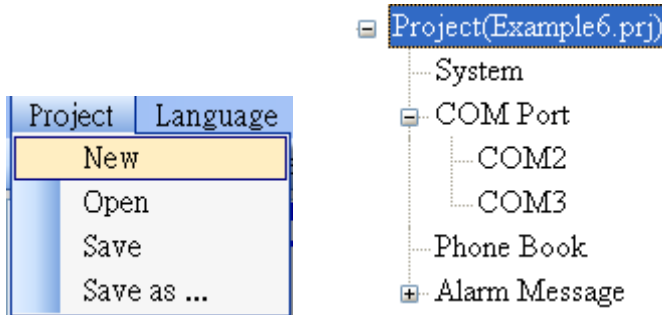

(2) Set the Modbus address as 1 (the factory default address is 1).

Project(Example6.prj) System COM1(232/485) Phone Book Alarm Message	Parameters	Value	Description
	Protocol	Modbus RTU	Read Only
	Modbus Address	1	1~247
	Variable SMS	Disable	Enable or Disable
	Alarm Mode	Level Trigger	Level or Edge Trigger

(3) Add 2 new phone groups and input phone numbers as follows:

Project(Example6.prj) System COM1(232/485) Phone Book group0 group1	Parameters	Value	Description
	Group Name	group0	1~10 Unicode Char.
	Phone 0	0123456789	
	Phone 1		
	Phone 2		
	Phone 3		

Project(Example6.prj) System COM1(232/485) Phone Book group0 group1	Parameters	Value	Description
	Group Name	group1	1~10 Unicode Char.
	Phone 0	9876543210	
	Phone 1		
	Phone 2		
	Phone 3		

(4)Set the “Voice Alarm” fields as enable in Alarm Channel0 and Alarm Channel1 as follows.

Parameters	Value	Description
Alarm Channel	0	Read Only
On Message	Channel0 ON	54 Unicode Char.
Off Message	Channel0 OFF	54 Unicode Char.
SMS Alarm	Disable	Enable or Disable
Voice Alarm	Enable	Enable or Disable
Trigger Time	0	0~9999 Secs
All Group	<input type="checkbox"/>	
group0	<input checked="" type="checkbox"/>	
group1	<input type="checkbox"/>	

Parameters	Value	Description
Alarm Channel	1	Read Only
On Message	Channel1 ON	54 Unicode Char.
Off Message	Channel1 OFF	54 Unicode Char.
SMS Alarm	Disable	Enable or Disable
Voice Alarm	Enable	Enable or Disable
Trigger Time	0	0~9999 Secs
All Group	<input type="checkbox"/>	
group0	<input type="checkbox"/>	
group1	<input checked="" type="checkbox"/>	

(5)Connect to the GTP-541M and download these parameters to the GTP-541M.

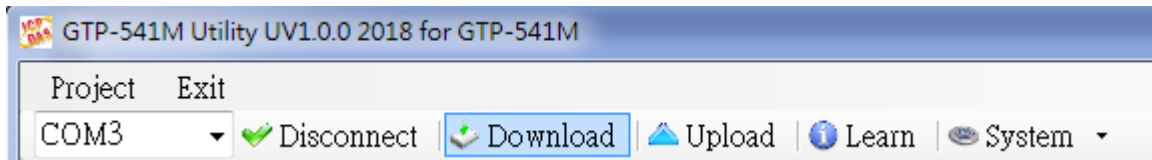

(6)Select the “System->Voice File Management” to download or confirm the voice files of the Alarm0 ON/OFF and Alarm1 ON/OFF are in the SD card.

Channel	Value	Existed	File at Device	File Format Status
Alarm0	ON	<input checked="" type="checkbox"/>	DO0_ON.WAV	Correct.
	OFF	<input checked="" type="checkbox"/>	DO0_OFF.WAV	Correct.
Alarm1	ON	<input checked="" type="checkbox"/>	DO1_ON.WAV	Correct.
	OFF	<input checked="" type="checkbox"/>	DO1_OFF.WAV	Correct.
Alarm2	ON	<input type="checkbox"/>	DO2_ON.WAV	No wav File.
	OFF	<input type="checkbox"/>	DO2_OFF.WAV	No wav File.



## 2. Modbus RTU command

(1) Connect COM1 (RS-232/RS-485) of the GTP-541M to the Host.



(2) The host sends the Modbus command to transmit the voice alarm from the GTP-541M.

Command and Description:

Command	Sending the voice alarm (16 Hex)	Command	01 05 00 00 FF 00 8C 3A
		Response	01 05 00 00 FF 00 8C 3A
Description	<p>1. As the GTP-541M receives the command, it would send the voice alarm. If the "SMS Alarm" is set as enable, the SMS would be sent.</p> <p>2. The voice file is DO0_ON.WAV.</p> <p>3. The voice is sent to the phones in the group0.</p>		
Result	<p>The phones in Group0 would receive the voice call from the GTP-541M. As take the call, you would hear the alarm voice in DO0_ON.WAV.</p>		

## Format Description:

Sending the voice alarm		
Command	Byte 0	The Modbus Address of the GTP-541M
	Byte 1	Function Code = 0x05
	Byte 2 ~ 3	Alarm Channel
	Byte 4 ~ 5	=0xFF00, To play DOx_ON.WAV file. The x is the number of Alarm channel. =0x0000, To play DOx_OFF.WAV file. The x is the number of Alarm channel.
	Byte 6 ~ 7	CRC-16 check code
Correct Response	Byte 0	The Modbus Address of the GTP-541M
	Byte 1	Function Code = 0x05
	Byte 2 ~ 3	Alarm Channel
	Byte 4 ~ 5	=0xFF00 or =0x0000
	Byte 6 ~ 7	CRC-16 check code

## 6. DIOSMS Utility main screen description

The GTP-541M SMS Utility layout mainly includes the following parts, which are described below. :

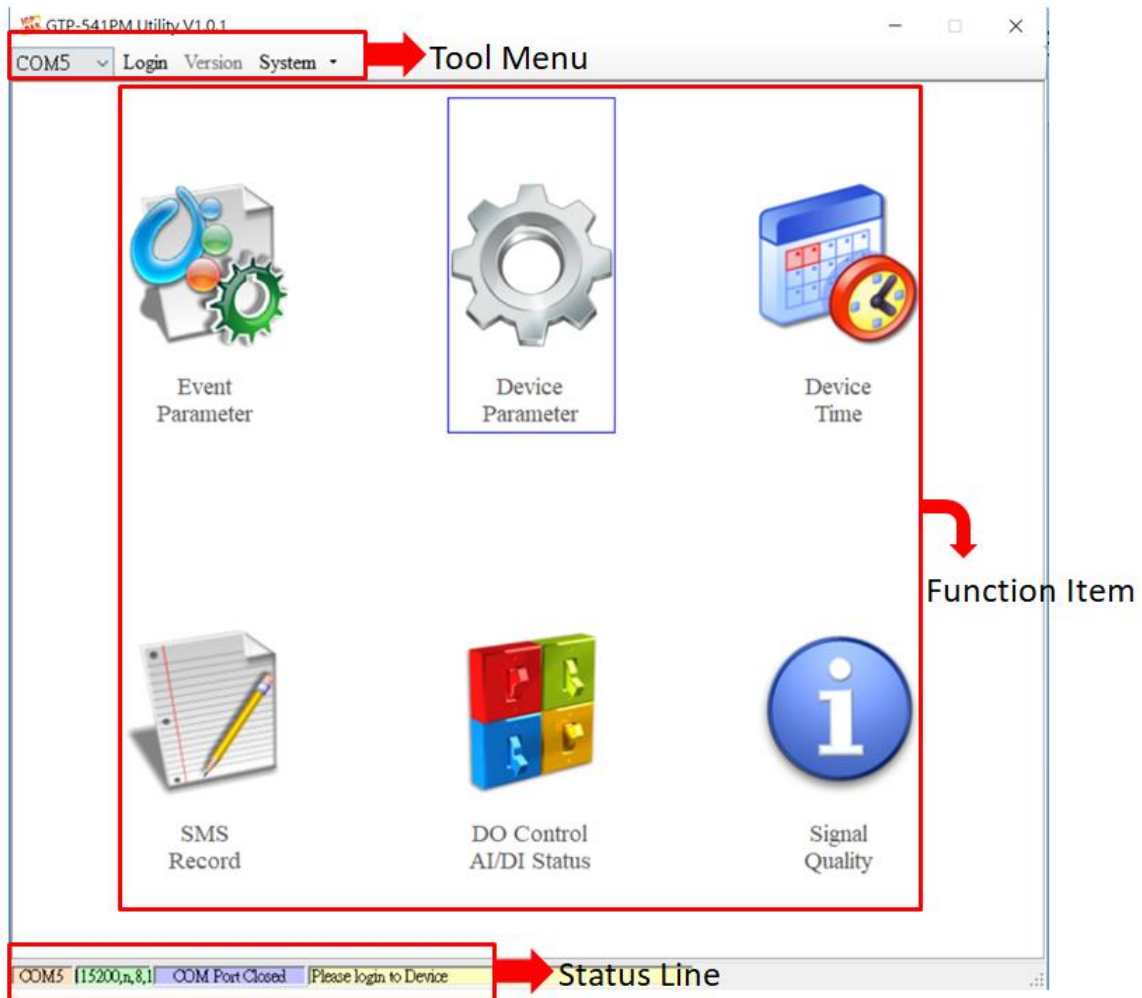

### Toolbar

#### ◆ COM :

Select PC-side COM PORT connected to GTP-541M

#### ◆ Login/Logout :

Before you can do anything with the GTP-541M, you must log in. After the login is successful, the option will be logged out, and the options in the Utility will allow the operation. If the SMS machine has been reopened or turned off, you must log in again.

◆ Version :

GTP-541M Firmware and Utility version information

◆ System :

There are two functions of Recover to Factory Settings and Restart GTP-541M (Reset Device)

## Function option

◆ Event Parameter :

Event related setting of GTP-541M.

◆ Device Parameter:

Set parameters for Comport related functions.

◆ SMS Record :

It can query the records of Auto Report events and SMS events, and display up to 1000 pens. The number of stored SMS messages increases or decreases depending on the content.

◆ Device Time :

Query and set device time.

◆ DO Control/DI/AI Status :

Query I/O status and DO control.

◆ Signal Quality :

Query the signal strength of the current device.

## **Status column**

Display information about the GTP-541M SMS Utility operation, from left to right, in order

- (1) PC-side COM Port number used by the Utility.
- (2) Transmission parameter setting of COM Port.
- (3) Current COM Port connection status.
- (4) The result of each operation, such as the “storage” action success or failure.

## 6.1 Main parameters

Set the block of 16 Event types, trigger conditions, trigger time, phone number and SMS content, etc:

### 6.1.1 Description of the Event Parameter

This is the page in the main parameter window. The parameters are as follows:

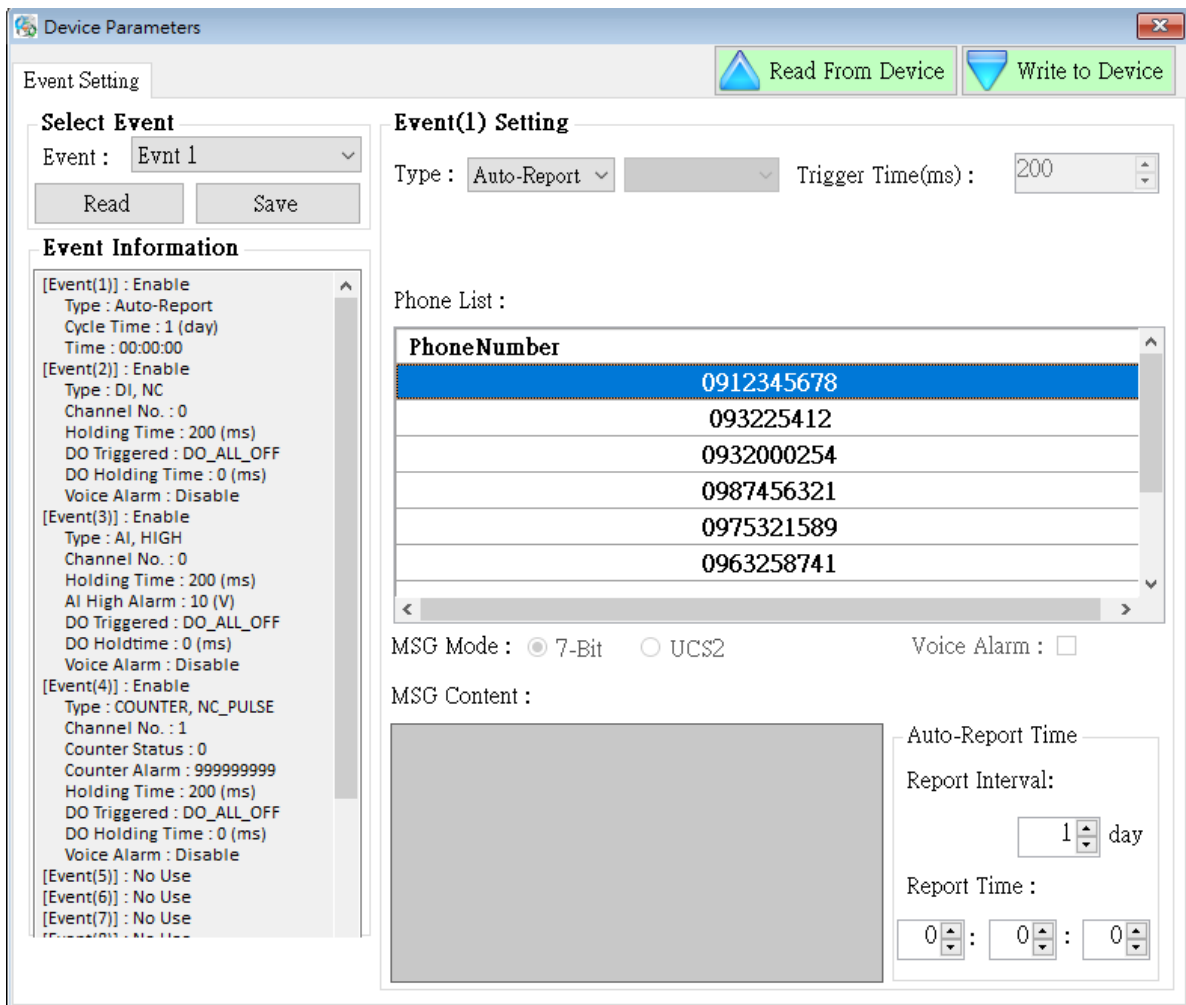

#### ◆ Select Event

Select to set the first few events, press Read when the selection is completed, it will switch to the setting options of the Event, a total of 16 events.

## ◆ Event Information

After the Event Setting is set, press the Select button of the Select Event, and the settings of each Event will be updated in the form, as shown in Figure 6.1.1

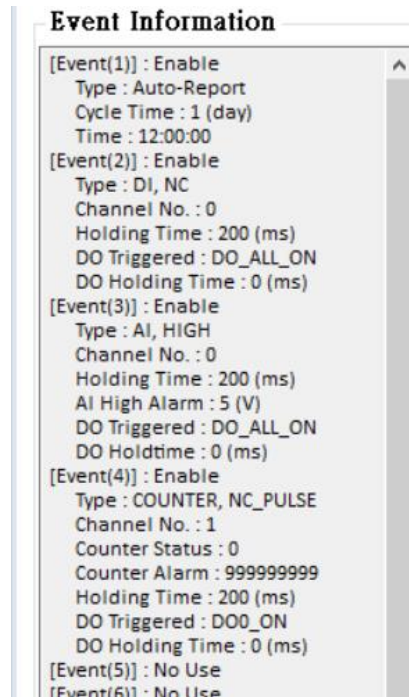

Figure 6.1.1

## ◆ Event(x) Setting

The number in the Event(x)Setting bracket indicates the Event number, and the Type indicates the type of the Event (DI/AI/Counter/AutoReport). The interface to be set for different Types is also different:

### 1. DI Type:

When Type selects DI, it will change the relevant setting interface to Figure 6.1.2:

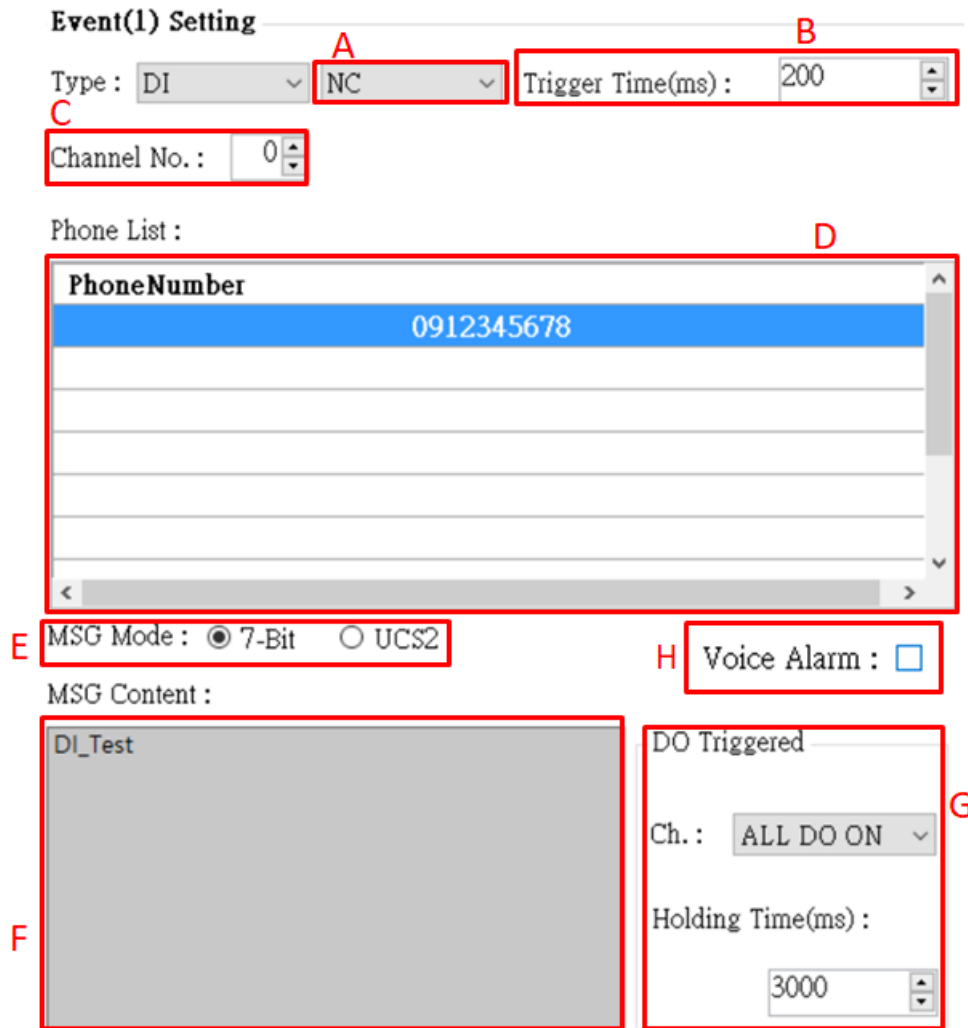

Figure 6.1.2

The parameters are as follows:

- A. When the NC (long-closed) is selected, the event is triggered after the circuit is disconnected. When NO (long open) is selected, the event is triggered after the circuit is closed. For the DI circuit, please refer to page 11.
- B. Setting the DI trigger signal needs to remain unchanged until the set time (in ms) .
- C. Set one of the DIs (0~4) as the monitoring point. When this point meets the set condition, an alarm will be triggered.

**Note 1:** DI points set by Counter type cannot be selected repeatedly .

- D. The target mobile phone number sent by the triggered alert message, up to 10 groups.
- E. The encoding of the content of the newsletter, only the English number can be input in 7-bit, and the multi-language can be input in UCS2.
- F. Content of the newsletter, up to 160 words in 7-bit, up to 70 words in UCS2, restricted characters: '!', '@', '>;!', '@' at the beginning of the newsletter or using '>', a parsing



error will occur, please do not use.

G.Select the DO that is turned on when the alarm is triggered:

Ch.:

There are four options “Not Trigger”, “DO0 ON”, “DO1 ON” and “ALL DO ON”. The four DO states can be selected, in order, “Do not turn on”, “Open DO0”, “Open DO1” "and" DO is fully open".

Holding Time (ms):

DO triggers the state to maintain the time, 0 means that it is always maintained, and other numbers are the calculation time. When the value reaches this value, the DO triggered by the alarm will be turned off. The time unit is ms.

H.Choose whether to turn on voice

2.AI Type:

When Type selects AI, it will change the relevant setting interface to Figure 6.1.3:

**Event(1) Setting**

Type : AI HIGH Trigger Time(ms) : 200

Channel No. : 0 AI High : 5.0000 AI Low : -10.0000

Phone List :

PhoneNumber
0912345678

MSG Mode :  7-Bit  UCS2 Voice Alarm :

MSG Content :

AI\_Test

DO Triggered

Ch. : ALL DO ON

Holding Time(ms) :

6000

Figure 6.1.3

The parameters are as follows:

- A. When “HIGH” is selected, the Ai input value is greater than the AI High value and the alarm will be triggered. When “LOW” is selected, the Ai input value is less than the AI Low value and the alarm will be triggered. When “HL” is selected, the Ai input value is greater than the AI High value or An alarm is triggered when the value is less than AI Low.
- B. The alarm will be triggered when the AI trigger value needs to be continuously higher or lower than the set value until the set time (in ms) is exceeded.
- C. Set one of the AI (0~3) as the monitoring point, which will trigger the alarm when it meets the set condition.
- D. Alarm trigger boundary for AI values.
- E. The target mobile phone number sent by the triggered alert message, up to 10 groups.
- F. The encoding of the content of the newsletter, only the English number can be input in 7-bit, and the multi-language can be input in UCS2.
- G. Content of the newsletter, up to 160 words in 7-bit, up to 70 words in UCS2, restricted characters: '!', '@', '>';!', '@' at the beginning of the newsletter or using '>', a parsing error will occur, please do not use.
- H. Select the DO that is turned on when the alarm is triggered:

Ch.:

There are four options “Not Trigger”, “DO0 ON”, “DO1 ON” and “ALL DO ON”. The four DO states can be selected, in order, “Do not turn on”, “Open DO0”, “Open DO1” and “DO is fully open”.

Holding Time (ms):

DO triggers the state to maintain the time, 0 means that it is always maintained, and other numbers are the calculation time. When the time reaches this value, the DO triggered by the alarm is turned off, and the time unit is ms.

- I. Choose whether to turn on voice

### 3. Counter Type:

When Type selects Counter, it will change the relevant setting interface to Figure 5.1.4:

Figure 6.1.4

The parameters are as follows:

- A. When NC\_PULSE is selected, the count value is increased by one after the circuit is disconnected. When NO\_PULSE is selected (long open), the count value is increased by one after the circuit is closed.
- B. Setting the DI trigger signal needs to remain unchanged until the set time (in ms).
- C. Set one of the DIs (0~4) as the monitoring point. When this point meets the set condition, the count value will increase.

**Note: The DI point set by DI type cannot be selected repeatedly.**

- D. Set the counter parameters, as shown in Figure 6.1.5
  - (1) Counter name, Counter0~Counter4 corresponds to DI0~DO4.
  - (2) Counter current count value.
  - (3) Set the current value of the counter.
  - (4) Counter usage status.
  - (5) The value of the counter trigger alarm, which must be greater than the value of Set Value by more than 10.

(6)Read the current status of Device Counters.

(7)Write Counters to Device.

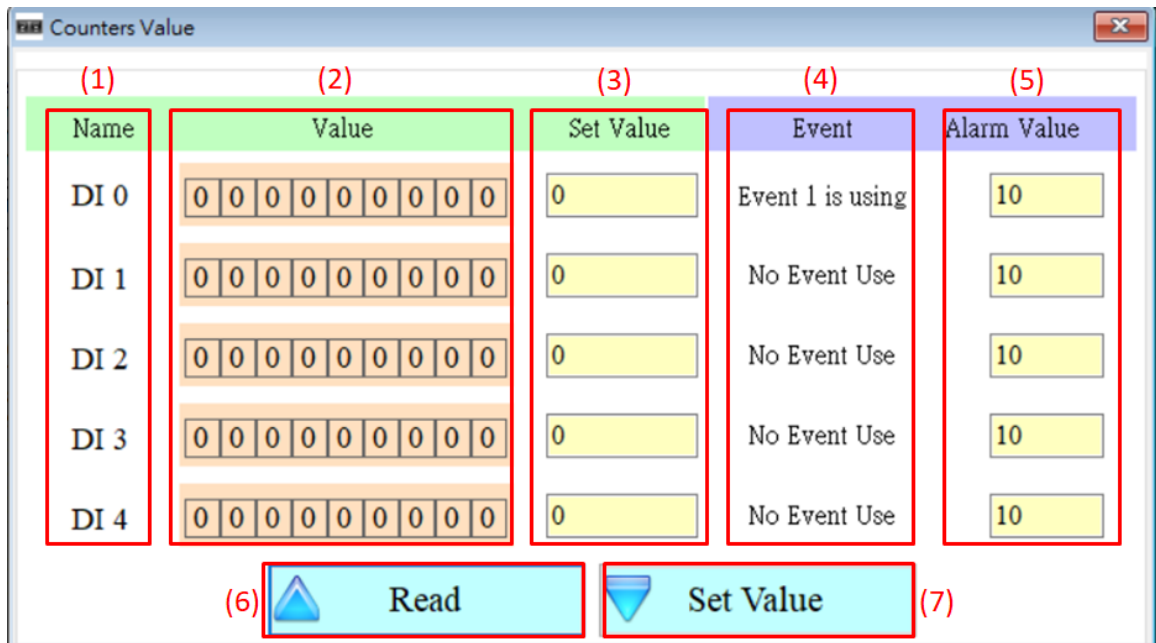

Figure 6.1.5

E. The target mobile phone number sent by the triggered alert message, up to 10 groups.

F. The encoding of the content of the newsletter, only the English number can be input in 7-bit, and the multi-language can be input in UCS2.

G. Content of the newsletter, up to 160 words in 7-bit, up to 70 words in UCS2, restricted characters: '!', '@', '>;!', '@' at the beginning of the newsletter or using '>', a parsing error will occur, please do not use.

H. Select the DO that is turned on when the alarm is triggered:

Ch.:

There are four options "Not Trigger", "DO0 ON", "DO1 ON" and "ALL DO ON". The four DO states can be selected, in order, "Do not turn on", "Open DO0", "Open DO1" "and" DO is fully open".

Holding Time (ms):

DO triggers the state to maintain the time, 0 means that it is always maintained, and other numbers are the calculation time. When the value reaches this value, the DO triggered by the alarm will be turned off. The time unit is ms.

I. Choose whether to turn on voice

4. Auto-Report Type:

When Type selects Auto-Report, it will change the relevant setting interface to Figure 6.1.6:

**Event(1) Setting**

Type : Auto-Report ▼ Trigger Time(ms) : 200

**A**

Phone List :

PhoneNumber

MSG Mode :  7-Bit  UCS2

MSG Content :

Voice Alarm :

Auto-Report Time **B**

Report Interval: 1 day

Report Time : 0 : 0 : 0 **C**

Figure 6.1.6

The parameters are as follows:

- A. The target mobile phone number sent by the triggered alert message, up to 10 groups.
- B. Set a few days to return once (1~30 days).
- C. Set the time for return, from left to right, respectively, hour, minute, second.

## 6.2 SMS Record Description

This window can query, store and delete the return record of Auto-Report and the return report of the newsletter event.

### 6.2.1 Auto-Report report

This page can be used to query the recorded Auto-Report report records in GTP-541M. The options and fields are as follows:

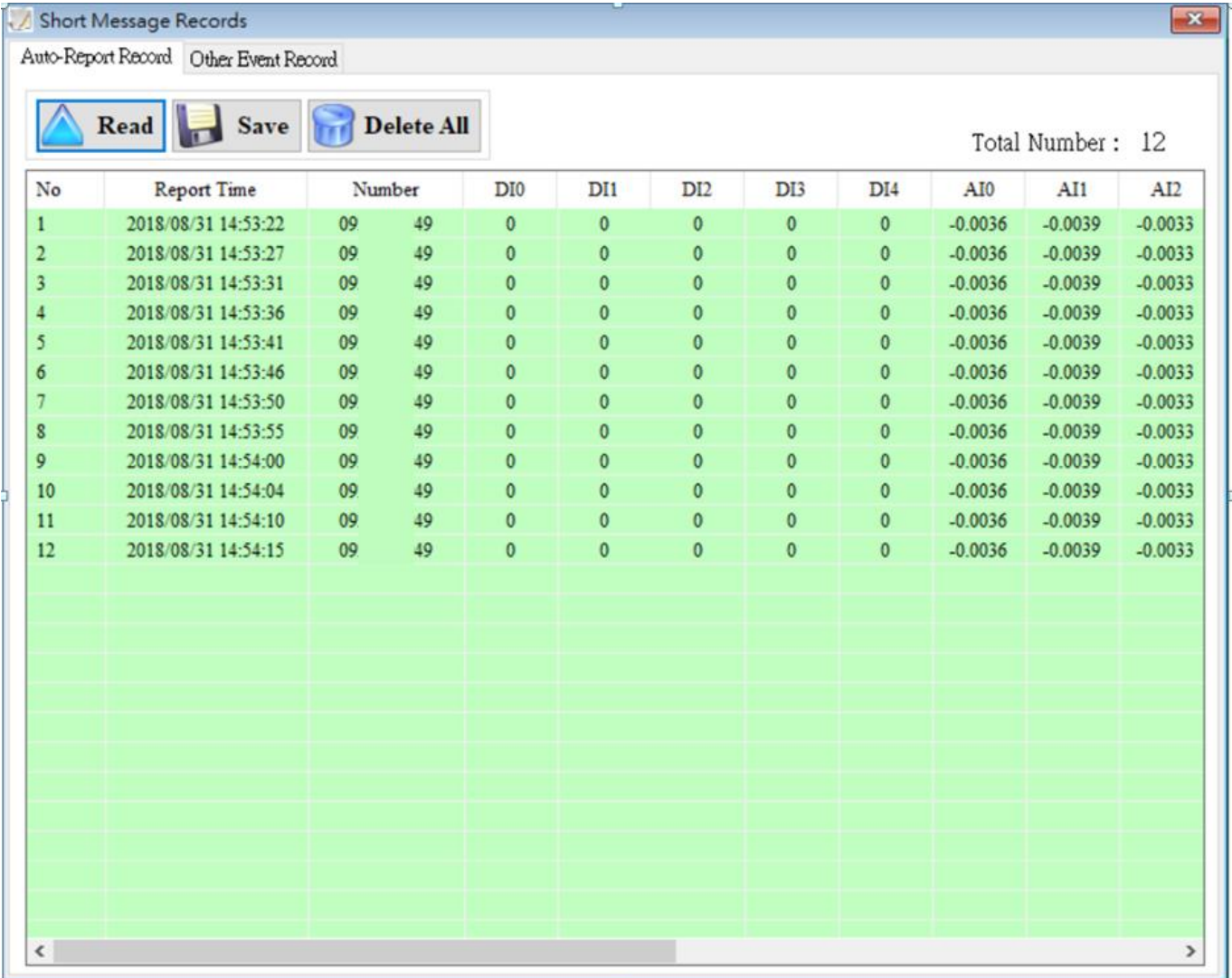

Short Message Records

Auto-Report Record Other Event Record

Read Save Delete All

Total Number : 12

No	Report Time	Number	DI0	DI1	DI2	DI3	DI4	AI0	AI1	AI2
1	2018/08/31 14:53:22	09 49	0	0	0	0	0	-0.0036	-0.0039	-0.0033
2	2018/08/31 14:53:27	09 49	0	0	0	0	0	-0.0036	-0.0039	-0.0033
3	2018/08/31 14:53:31	09 49	0	0	0	0	0	-0.0036	-0.0039	-0.0033
4	2018/08/31 14:53:36	09 49	0	0	0	0	0	-0.0036	-0.0039	-0.0033
5	2018/08/31 14:53:41	09 49	0	0	0	0	0	-0.0036	-0.0039	-0.0033
6	2018/08/31 14:53:46	09 49	0	0	0	0	0	-0.0036	-0.0039	-0.0033
7	2018/08/31 14:53:50	09 49	0	0	0	0	0	-0.0036	-0.0039	-0.0033
8	2018/08/31 14:53:55	09 49	0	0	0	0	0	-0.0036	-0.0039	-0.0033
9	2018/08/31 14:54:00	09 49	0	0	0	0	0	-0.0036	-0.0039	-0.0033
10	2018/08/31 14:54:04	09 49	0	0	0	0	0	-0.0036	-0.0039	-0.0033
11	2018/08/31 14:54:10	09 49	0	0	0	0	0	-0.0036	-0.0039	-0.0033
12	2018/08/31 14:54:15	09 49	0	0	0	0	0	-0.0036	-0.0039	-0.0033

## Operating option description

### ◆ Read :

Read the transmission record and data of Auto-Report from GTP-541M, and display up to 1000 pens.

### ◆ Save :

Save the record as a .csv file.

### ◆ Delete All :

Remove all return records from GTP-541M.

### ◆ Total Number

Total number of fields.

## Field description

### ◆ No :

Record number.

### ◆ Report Time :

Time on the GTP-541M when the newsletter is sent.

### ◆ Number :

Phone number sent to the target.

### ◆ DI(0~4) :

DI status.

### ◆ AI(0~3):

AI value.

### ◆ CI(0~4):

Counter value.

## ◆DO(0~1):

DO status.

## 6.2.2 Event record query

This page can be used to query the records of all incoming events in GTP-541M. The options and fields are as follows :

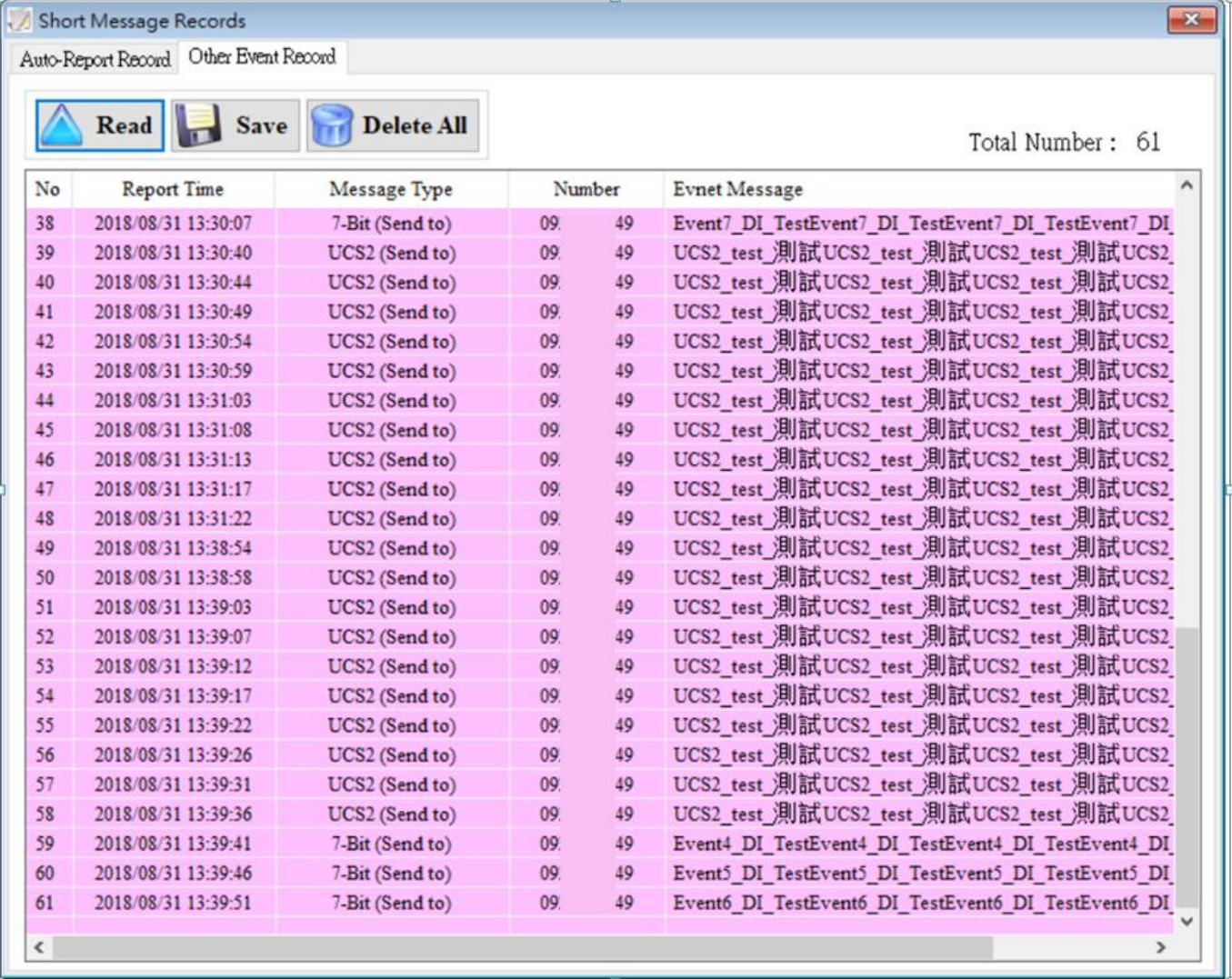

No	Report Time	Message Type	Number	Event Message
38	2018/08/31 13:30:07	7-Bit (Send to)	09. 49	Event7_DI_TestEvent7_DI_TestEvent7_DI_TestEvent7_DI
39	2018/08/31 13:30:40	UCS2 (Send to)	09. 49	UCS2_test_測試UCS2_test_測試UCS2_test_測試UCS2
40	2018/08/31 13:30:44	UCS2 (Send to)	09. 49	UCS2_test_測試UCS2_test_測試UCS2_test_測試UCS2
41	2018/08/31 13:30:49	UCS2 (Send to)	09. 49	UCS2_test_測試UCS2_test_測試UCS2_test_測試UCS2
42	2018/08/31 13:30:54	UCS2 (Send to)	09. 49	UCS2_test_測試UCS2_test_測試UCS2_test_測試UCS2
43	2018/08/31 13:30:59	UCS2 (Send to)	09. 49	UCS2_test_測試UCS2_test_測試UCS2_test_測試UCS2
44	2018/08/31 13:31:03	UCS2 (Send to)	09. 49	UCS2_test_測試UCS2_test_測試UCS2_test_測試UCS2
45	2018/08/31 13:31:08	UCS2 (Send to)	09. 49	UCS2_test_測試UCS2_test_測試UCS2_test_測試UCS2
46	2018/08/31 13:31:13	UCS2 (Send to)	09. 49	UCS2_test_測試UCS2_test_測試UCS2_test_測試UCS2
47	2018/08/31 13:31:17	UCS2 (Send to)	09. 49	UCS2_test_測試UCS2_test_測試UCS2_test_測試UCS2
48	2018/08/31 13:31:22	UCS2 (Send to)	09. 49	UCS2_test_測試UCS2_test_測試UCS2_test_測試UCS2
49	2018/08/31 13:38:54	UCS2 (Send to)	09. 49	UCS2_test_測試UCS2_test_測試UCS2_test_測試UCS2
50	2018/08/31 13:38:58	UCS2 (Send to)	09. 49	UCS2_test_測試UCS2_test_測試UCS2_test_測試UCS2
51	2018/08/31 13:39:03	UCS2 (Send to)	09. 49	UCS2_test_測試UCS2_test_測試UCS2_test_測試UCS2
52	2018/08/31 13:39:07	UCS2 (Send to)	09. 49	UCS2_test_測試UCS2_test_測試UCS2_test_測試UCS2
53	2018/08/31 13:39:12	UCS2 (Send to)	09. 49	UCS2_test_測試UCS2_test_測試UCS2_test_測試UCS2
54	2018/08/31 13:39:17	UCS2 (Send to)	09. 49	UCS2_test_測試UCS2_test_測試UCS2_test_測試UCS2
55	2018/08/31 13:39:22	UCS2 (Send to)	09. 49	UCS2_test_測試UCS2_test_測試UCS2_test_測試UCS2
56	2018/08/31 13:39:26	UCS2 (Send to)	09. 49	UCS2_test_測試UCS2_test_測試UCS2_test_測試UCS2
57	2018/08/31 13:39:31	UCS2 (Send to)	09. 49	UCS2_test_測試UCS2_test_測試UCS2_test_測試UCS2
58	2018/08/31 13:39:36	UCS2 (Send to)	09. 49	UCS2_test_測試UCS2_test_測試UCS2_test_測試UCS2
59	2018/08/31 13:39:41	7-Bit (Send to)	09. 49	Event4_DI_TestEvent4_DI_TestEvent4_DI_TestEvent4_DI
60	2018/08/31 13:39:46	7-Bit (Send to)	09. 49	Event5_DI_TestEvent5_DI_TestEvent5_DI_TestEvent5_DI
61	2018/08/31 13:39:51	7-Bit (Send to)	09. 49	Event6_DI_TestEvent6_DI_TestEvent6_DI_TestEvent6_DI

## Record field description

## ◆Read :

Read all event records from GTP-541M, display up to 1000 pens, and increase the number of stored SMS messages according to the amount of content.



◆ Save :

Store event log file.

◆ Delete All :

Remove all event records from GTP-541M containing Auto-Report events.

◆ Total Number

Total number of fields.

## Field description

◆ No :

Event record number.

◆ Report Time :

Time on GTP-541M when sending newsletters.

◆ Message Type :

Newsletter type.

◆ Number :

Send a text message and receive the destination phone number of the newsletter.

◆ Event Message :

Newsletter content of the event.

## 6.3 Device Time Parameter Description

Through this window, you can change and query the time of GTP-541M. The following are the operation options and descriptions of the fields :

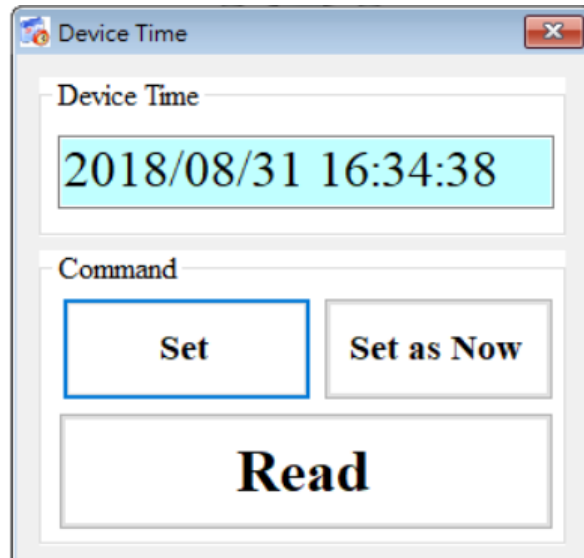

### Field description

◆ Device Time :

Display device current time.

◆ Command :

Set time and read time.

### Operating option description

◆ Set :

The user can enter the date and time into the Device Time field, and Set will set the time in the Device Time field to the device.

◆ Set as Now :

Read the current date and time of the PC and set it to the device.

◆ Read :

Display device current time.

## 6.4 Device Parameter Parameter Description

This window provides functions for setting the device name and communication, communication parameters, etc. The operation options and fields are as follows:

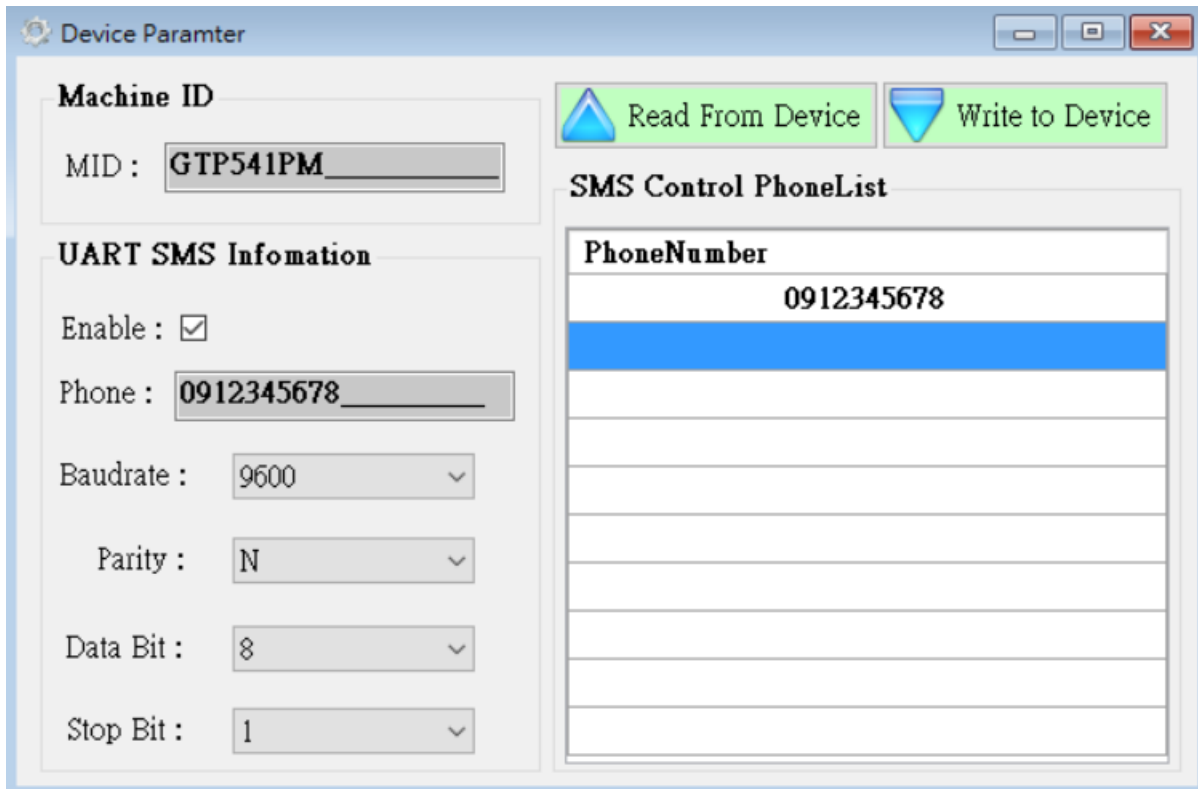

### Field description

#### ◆ Machine ID :

Users can customize the device name from this.

#### ◆ Uart SMS Information :

The user can set the UART parameters by this function. The function is to send the beginning of the "+++" through the Uart and the "message content" to trigger the GTP-541M to send the SMS. The content of the message is "+++".

For example: Uart sends +++Uart\_Test, GTP-541M will send a message with Uart\_Test to the phone number 0912345678.

◆ SMS Control PhoneList :

The telephone number of the authority control device can be set accordingly. For related instructions, please refer to page 69.

## Operating option description

◆ MID :

The name of the GTP-541M.

◆ Enable :

Whether to enable the Uart SMS Command function.

◆ Phone :

Receive the phone number of the newsletter.

◆ Baudrate:

Comport Baudrate for RS-232/RS-485 °

◆ Parity:

Comport Parity of RS-232/RS-485.

◆ Data Bit:

Comport Data Bit for RS-232/RS-485.

◆ Stop Bit:

Comport Stop Bit for RS-232/RS-485.

◆ Phone Number:

Phone number with permission to query and set the device.

◆ Read From Device:

Read related settings from Device.

◆ Write to Device:

Write Device related settings.

## 6.5 DO Control AI/DI Status Description

The user can read the current state of the I/O on the device and manually control the DO state, and the operation options and fields are as follows:

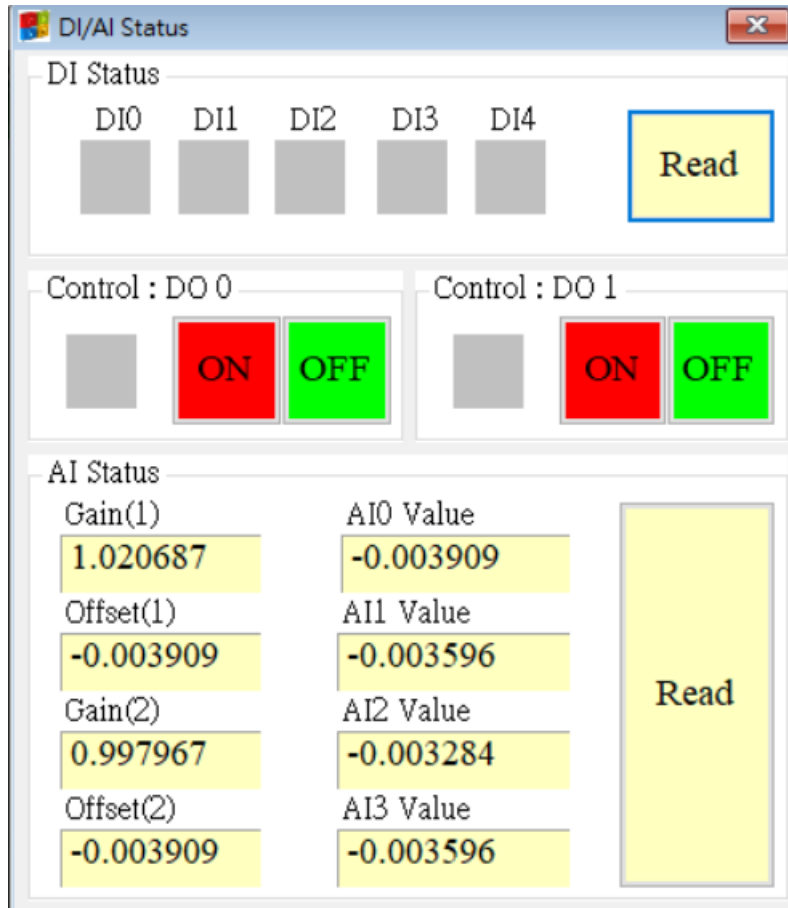

### DI Status

◆ Red :

When DI is ON, the status is low.

◆ Gray :

When DI is OFF, the status is high.

◆ Read

Read DI/DO status.

## **Control : DO0 、 DO1**

### ◆ Red :

When DI is ON, the status is low.

### ◆ Gray :

When DI is OFF, the status is high.

### ◆ ON:

Turn on DO0, DO1.

### ◆ OFF:

Close DO0, DO1.

## **AI Status**

### ◆ AI0(~3) Value :

The AI value currently read, in volts (V).

### ◆ Gain(1~2) :

AI correction value, read only. If Gain is 1, Offset is 0, please contact us.

### ◆ Offset(1~2) :

AI correction value, read only. If Gain is 1, Offset is 0, please contact us.

### ◆ Read:

Read AI voltage value.

## 6.6 Signal Quality Description

This window can be used to query the signal strength received on the GTP-541M.

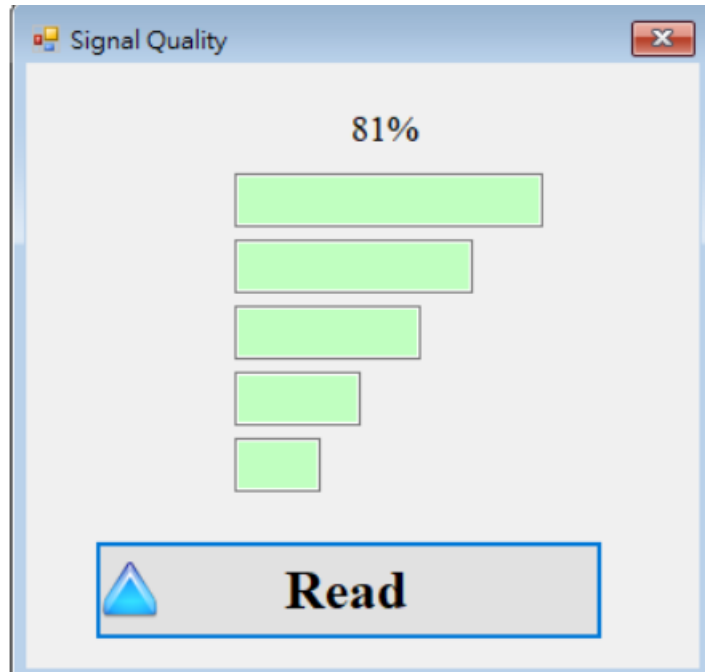

### Signal Quality field description

The signal strength is expressed in 5 segments and shows the current percentage of signal strength.

### Operating option description

◆ Read :

Read the current signal strength from GTP-541M.



## 6.7 Version Information Description

Click "Version" in the toolbar to display the version of SMS Utility and the version information of the firmware that can be queried :

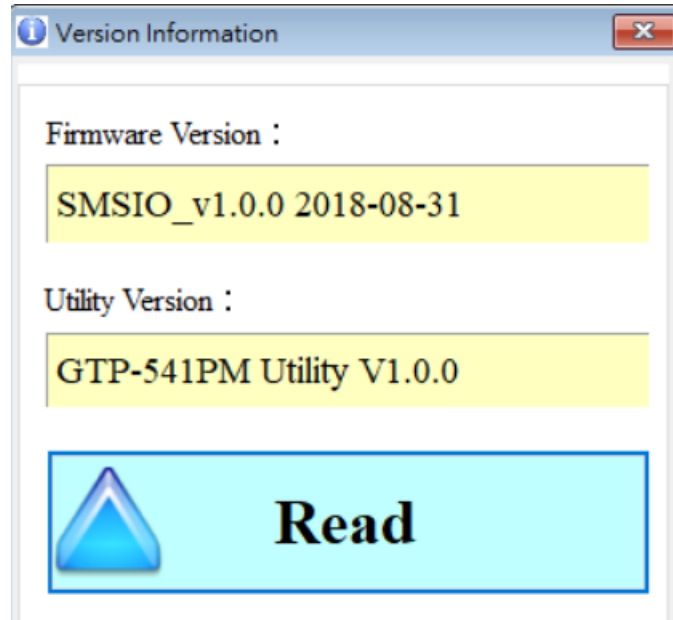

### Field description

◆ Firmware Version :

Display firmware version information.

◆ Utility Version :

Display version information of SMS Utility.

### Operating option description

◆ Read :

Read the firmware version information from GTP-541M and display it in the window.

## 6.8 System Description

In the drop-down menu "System", there are two functions "ReCover to Factory Settings" and "Reset Device". The function description and operation mode of the two are as follows:

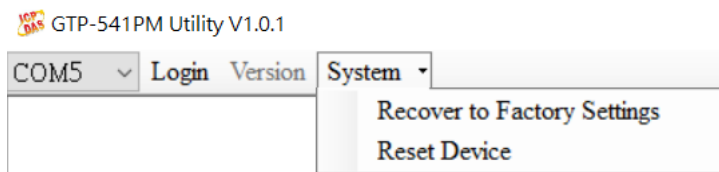

### 6.8.1 ReCover to Factory Settings Instructions

This option restores the parameters to the factory settings, including the password, as follows:

(1)Click "System" → "ReCover to Factory Settings" .

### 6.8.2 Reset Device Description

This option restarts the GTP-541M in software mode as follows:

(1)Click "System" → "Reset Device" .

### 6.8.3 PIN Code Description

This option can be used to set the password required for the SIM card to be opened. After the setting is completed, restart the GTP-541M and apply it. If the SIM card does not require a password, it will not be entered even if it is set.

### 6.8.4 Voice File Status Description

This option is to confirm whether the name and format of the voice file in the SD card are correct. If the format and name are correct, the Correct and Existing status will be checked.

## 6.9 Voice file format, status and on

**Note:** The voice file function can only be used in firmware version 1.20 or higher and Utility version 1.1.0 or higher.

- 一、Please add a voice folder to the SD first, and then put the specified voice file into the voice folder.

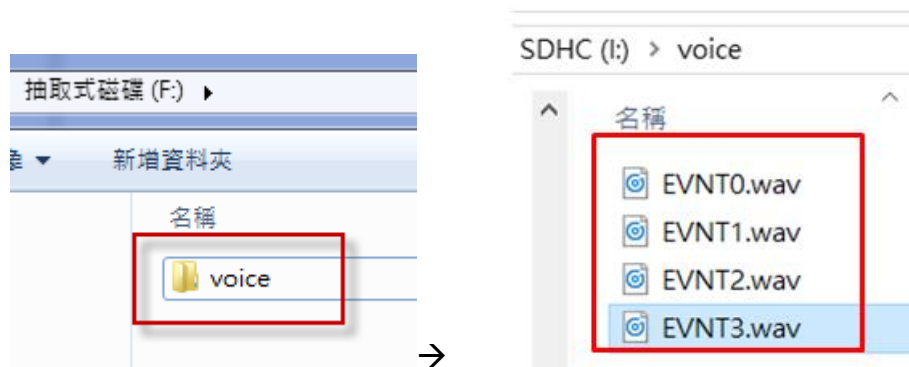

- 二、Click "System->Voice File Status" in the Utility interface to check whether the current voice file status and format in the SD match.

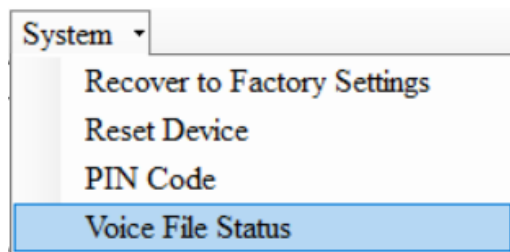

The Voice File Status page can view the voice file corresponding to each EVENT. If the file exists, the Existed item will display a tick, and the File Format Status item displays whether the current voice file format meets the voice dialing requirements. If it matches, the green background will be displayed "Correct", if it does not match, it displays "Incorrect" with a red background. Once the system detects that the voice file format does not meet the playback requirements, even if this event is triggered, the voice alarm will not be activated. Please correct the voice file format to meet the playback requirements.

Event	Existed	File at Device	File Format Status
Event 1	<input checked="" type="checkbox"/>	EVNT0.WAV	Correct.
Event 2	<input checked="" type="checkbox"/>	EVNT1.WAV	Correct.
Event 3	<input checked="" type="checkbox"/>	EVNT2.WAV	Correct.
Event 4	<input checked="" type="checkbox"/>	EVNT3.WAV	Incorrect!
Event 5	<input type="checkbox"/>	EVNT4.WAV	No wav File.
Event 6	<input type="checkbox"/>	EVNT5.WAV	No wav File.
Event 7	<input type="checkbox"/>	EVNT6.WAV	No wav File.
Event 8	<input type="checkbox"/>	EVNT7.WAV	No wav File.
Event 9	<input type="checkbox"/>	EVNT8.WAV	No wav File.
Event 10	<input type="checkbox"/>	EVNT9.WAV	No wav File.
Event 11	<input type="checkbox"/>	EVNT10.WAV	No wav File.
Event 12	<input type="checkbox"/>	EVNT11.WAV	No wav File.
Event 13	<input type="checkbox"/>	EVNT12.WAV	No wav File.
Event 14	<input type="checkbox"/>	EVNT13.WAV	No wav File.
Event 15	<input type="checkbox"/>	EVNT14.WAV	No wav File.
Event 16	<input type="checkbox"/>	EVNT15.WAV	No wav File.

SD Card OK Get the parameters successfully.

三、 Enable sending voice files

(1) Click “Event Parameter” in the Utility interface to view the current Event settings.



(2) In the selected Event settings, you can see the "Voice Alarm" option, tick to open this Event voice file function.

**Note: Voice mode is only available for DI, AI and Counter.**

**Event(1) Setting**

Type : DI NC Trigger Time(ms) : 200

Channel No. : 0

Phone List :

PhoneNumber

MSG Mode :  7-Bit  UCS2 **Voice Alarm :**

MSG Content :

DO Triggered

Ch. : Not Trigger

Holding Time(ms) : 0

(3) After the setting is completed, it will confirm whether there is a corresponding voice file for this event. If the confirmation is correct, it will display OK. If the error is displayed, err will be displayed. The error may be due to the file not being present or the format is wrong.

**Event Information**

[Event(1)] : Enable  
 Type : DI, NC  
 Channel No. : 1  
 Holding Time : 200 (ms)  
 DO Triggered : DO\_ALL\_OFF  
 DO Holding Time : 0 (ms)  
**Voice Alarm : Enable(WAV ok)**

[Event(2)] : No Use

[Event(3)] : No Use

[Event(4)] : No Use

[Event(5)] : Enable  
 Type : DI, NC  
 Channel No. : 0  
 Holding Time : 200 (ms)  
 DO Triggered : DO\_ALL\_OFF  
 DO Holding Time : 0 (ms)  
**Voice Alarm : Enable(WAV err)**

#### 四、Voice File Format

GTP-541M only supports the playback of WAV files. The following formats are required. For example, voice files are not in the following format. Please use the software to convert:

File type	wav
Audio format	PCM
Audio sample size	16 bits
Channel	mono
Audio sampling frequency	8 kHz
Audio bit rate	128kbps

## 6.10 SMS instruction description

Through the SMS command, you can use the phone to send commands to the GTP-541M to complete pre-defined actions, such as controlling the DO output to be ON. To achieve this function, the phone number of the next command must be set in the SMS PhoneList of Device Parameter.

SMS instruction summary

SMS command	Description
@TIME	Time setting / query
@DOCn	DO control
@ACTV	Count value query
@DIV	DI/DO status query
@AIV	AI status query

### 6.10.1 @TIME(Time setting / query)

#### (1)Description

Set or query the current time of GTP-541M.

#### (2)Request

##### set up

```
@TIME; YYYYMMDD; HHmmSS
```

##### Inquire

```
@TIME
```

##### Field description

YYYYMMDD : The date to be set, 8 characters long, respectively, the year, month, and day of the year.

HHmmSS : The time to be set, the length of 6 characters, respectively (24-hour clock), minutes, seconds.

##### Example :

Set the time of the SMS machine to 2018/08/30 12:05:30

```
@TIME;20180830;120530
```

Query the current time of the SMS :

```
@TIME
```

#### (3)Response

##### Format

```
!MID;TIME;Result;YYYYMMDD;HHmmSS
```

##### Field description

MID : Device code.

TIME : This command name.

Result : Command execution result.

OK → Set or query success.

ER → The format entered is incorrect or does not have this permission.

Others : The format entered is incorrect or does not have this permission....

##### Example :

```
!GTP-541M;TIME;OK;20090410;100300
```



## 6.10.2 @DOCn(DO control)

### (1)Description

Control DO output.

### (2)Request

#### Set up

```
@DOCn;CMD;millisecond
```

```
@DOCn;CMD
```

#### Field description

n : 0 ~ 4

CMD :

ON → DO output is ON.

OFF → DO output is OFF.

PULSE → Keep the DO output ON for the set number of seconds. After the time has elapsed, the DO output is OFF..

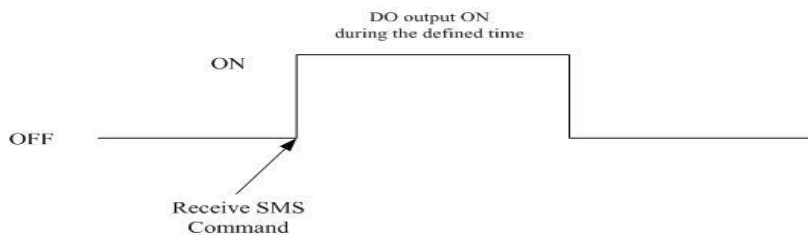

Second : When the control command is PLUS, the number of seconds that the DO output is ON (maximum: 8640000ms, 24HR per day).

#### Example :

Control DO1 output to ON :

```
@DOC1;ON
```

Controls the time when the DO1 output is ON for 5000 milliseconds (ms) :

```
@DOC1;PLUS;5000
```

### (3)Response

#### Format

```
!MID;DOCn; Result; CMD;millisecond
```

#### Field description

MID : Device code.

DOC : This command name.

Result : Command execution result.

OK → Control success.

ER → The format entered is incorrect or does not have this permission.

CMD, millisecond : Same as in the command format.

**Example :**

```
!GTP-541M;DOC1;OK;ON
```

```
!GTP-541M;DOC1;OK;PLUS;5000
```

### 6.10.3 @ACTV(Count value query)

**(1)Description**

Query counter current count value.

**(2)Request**

**Inquire**

```
@ACTV
```

**Example :**

```
@ACTV
```

**(3)Response**

**Format**

```
!MID;ACTV;Result;CT0;CT1;CT2;CT3;CT4
```

**Field description**

MID : Device code.

ACTV : This command name.

Result : Command execution result.

OK → search successful.

ER → The format entered is incorrect or does not have this permission.

DI0 ~ 4 : DI0 ~ 4 The current count value, if you want to reset it, it will be changed by

Utility.

**Example :**

```
!GTP-541M;ACTV;OK;3;3;3;3;3
```

## 6.10.4 @DIV(DI/DO status query)

### (1)Description

Query the current actual status value (0 or 1) of the DI point and the DO point ◦

### (2)Request

#### Inquire

@DIV

#### Example :

@DIV

### (3)Response

#### Format

```
!MID;DIV; Result;DI0;DI1;DI2;DI3;DI4;DO0;DO1
```

#### Field description

MID : Device code.

DIV : This command name.

Result : Command execution result.

OK → search successful.

ER → The format entered is incorrect or does not have this permission.

DI0 ~ DI4 : DI current actual status value.

0 → Low Voltage.

1 → High Voltage.

DO0 ~ DO1 : DO current actual status value.

0 → Low Voltage.

1 → High Voltage.

#### Example :

```
!GTP-541PM;DIV;OK;0;0;0;0;0;1;0
```

### 6.10.5 @AIV (AI status query)

#### (1)Description

Query the current status value of the AI point.

#### (2)Request

**Inquire**

@AIV

**Example :**

@AIV

#### (3)Response

**Format**

!MID;AIV; Result; AI0 value; AI1 value; AI2 value; AI3 value

**Field description**

MID : Device code.

AIV : This command name.

Result : Command execution result.

OK → search successful.

ER→ The format entered is incorrect or does not have this permission.

AI<sub>n</sub> value : Corrected AI value.

**Example :**

!GTP-541M;AIV;OK; 4.999; 4.999;0.005;0.003

## 6.11 DIOSMS usage examples

### — 、 Event DI setting and testing

A. Determine that the 4th pin and the 5th pin on the GTP-541M are successfully connected, as shown in Figure 6.10.1

COM Port and Power Input		
Pin		Description
Frame Ground	1	F.G
Power Input : +10V <sub>DC</sub> ~ +30V <sub>DC</sub>	2	P.GND
	3	PWR
Init.	4	GND
	5	Init.
COM 1 RS-485	6	D-
	7	D+
COM 1 Utility Port RS-232	8	GND
	9	RxD
	10	TxD

Figure 6.10.1

B. Click “Login” on the Utility screen. As shown in Figure 6.10.2, if the connection is successful, the “Login” button will change to “Logout”, as shown in Figure 6.10.3

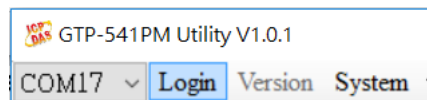

Figure 6.10.2

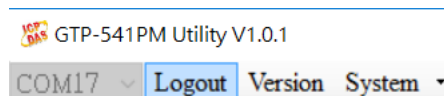

Figure 6.10.3

C. Select “Event Parameter” in the function option as shown in Figure 6.10.4



Figure 6.10.4

D. First select Event and press “Read” as shown in Figure 6.10.5

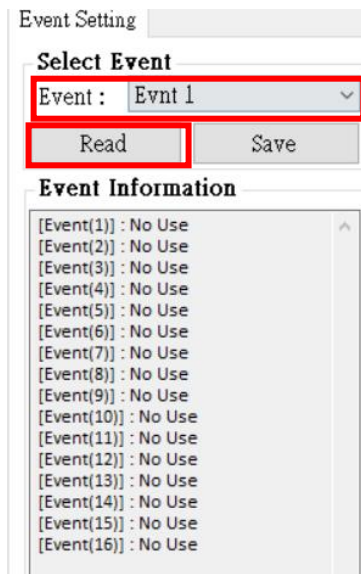

Figure 6.10.5

E. Select “DI” in Type as shown in Figure 6.10.6. After selecting, it will pop up the attention window and select “Yes” as shown in Figure 6.10.7

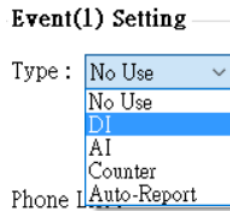

Figure 6.10.6

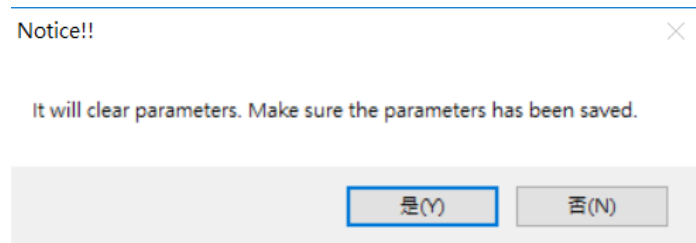

Figure 6.10.7

F. Select trigger condition as “NC”, Trigger Time “200ms” and Channel No. “0” as shown in Figure 6.10.8



Figure 6.10.8

G. Refill the target phone number, as shown in Figure 6.10.9

Phone List :

PhoneNumber
0912345678

Figure 6.10.9

H. Select the alert message content encoding method and fill in the alert message content as shown in Figure 6.10.10

MSG Mode :  7-Bit     UCS2

MSG Content :

DI\_test|

Figure 6.10.10

I. Select the setting for DO when triggering the alarm, Ch select “ALL DO ON” to turn on DO0 and DO1, and Holding Time (ms) to select “6000” ms to let DO turn on after 6 seconds, as shown in Figure 6.10.11

DO Triggered

Ch. :  ▾

Holding Time(ms) :

▾

Figure 6.10.11

J. After setting, select “SAVE” to save as shown in Figure 6.10.12. Complete the list below to display the settings just made.

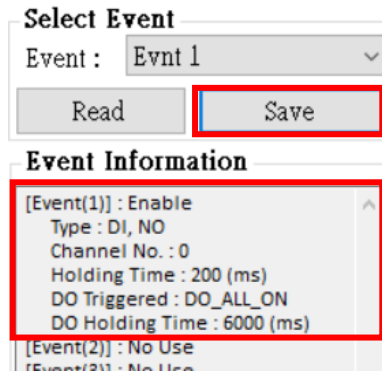

Figure 6.10.12

K. After confirming the completion, click “Write to Device”. As shown in Figure 5.10.13, write the settings to GTP-541M. At this time, the confirmation window will pop up and click OK. As shown in Figure 5.10.14, the parameters will be written. Information, after completion, will jump out of the success window as shown in Figure 5.10.15

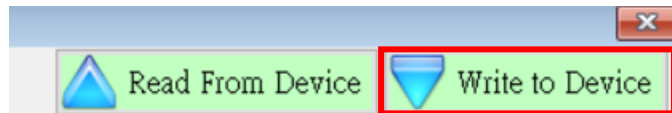

Figure 6.10.13

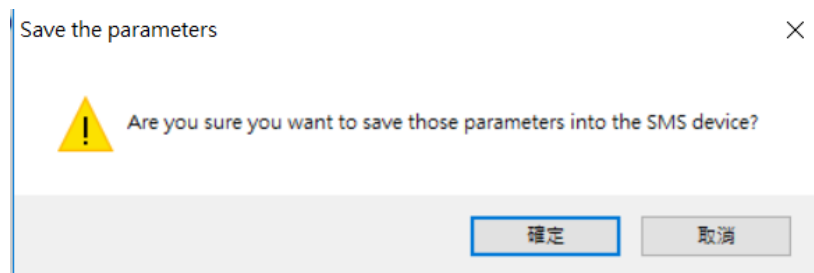

Figure 6.10.14

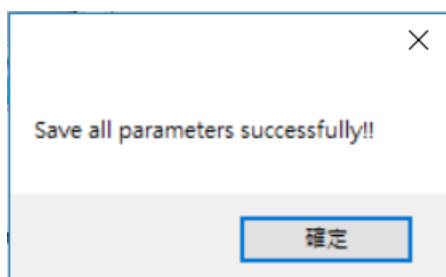

Figure 6.10.15

L.L. Then unplug the 4th pin and the 5th pin on the GTP-541M as shown in Figure 5.10.16, and restart the GTP-541M.



COM Port and Power Input		
Pin		Description
Frame Ground	1	F.G
Power Input : +10V <sub>DC</sub> ~ +30V <sub>DC</sub>	2	P.GND
	3	PWR
Init.	4	GND
	5	Init.
COM 1 RS-485	6	D-
	7	D+
COM 1 Utility Port RS-232	8	GND
	9	RxD
	10	TxD

Figure 6.10.16

M. After confirming that the STA light starts to flash normally, input the trigger signal to DI0, and the input mobile phone will receive the alarm message.

二、 Event Counter setting and testing

A. Determine that the 4th pin and the 5th pin on the GTP-541M are successfully connected, as shown in Figure 6.10.17

COM Port and Power Input		
Pin		Description
Frame Ground	1	F.G
Power Input : +10V <sub>DC</sub> ~ +30V <sub>DC</sub>	2	P.GND
	3	PWR
Init.	4	GND
	5	Init.
COM 1 RS-485	6	D-
	7	D+
COM 1 Utility Port RS-232	8	GND
	9	RxD
	10	TxD

Figure 6.10.17

B. Click “Login” on the Utility screen. As shown in Figure 6.10.18, if the connection is successful, the “Login” button will change to “Logout”, as shown in Figure 6.10.19

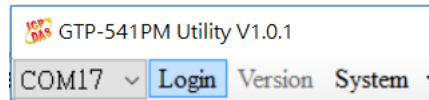

Figure 6.10.18

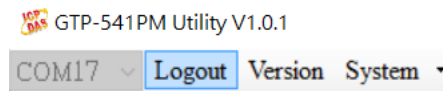

Figure 6.10.19

C. Select “Event Parameter” in the function option as shown in Figure 6.10.20



Figure 6.10.20

D. First select Event and press "Read" as shown in Figure 6.10.21

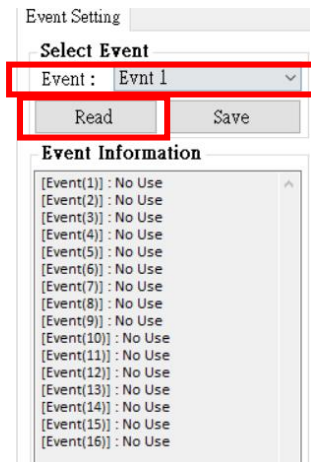

Figure 6.10.21

E. Select “Counter” in Type as shown in Figure 6.10.22. After selecting, it will pop up the attention window and select “Yes” as shown in Figure 6.10.23

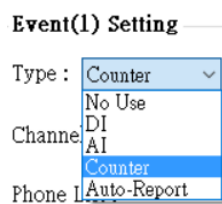

Figure 6.10.22

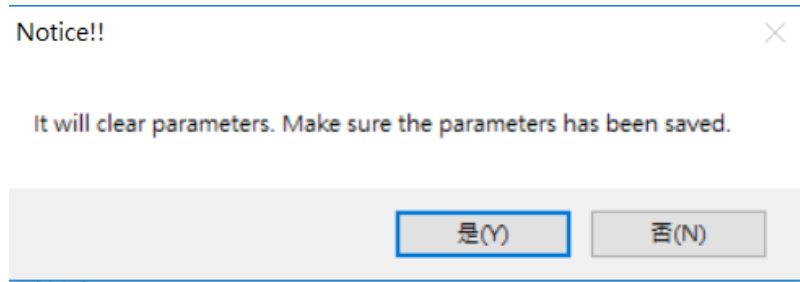

Figure 6.10.23

F. Select the trigger condition as "NO\_PULSE", Trigger Time "200ms" and Channel No. "0", as shown in Figure 6.10.24

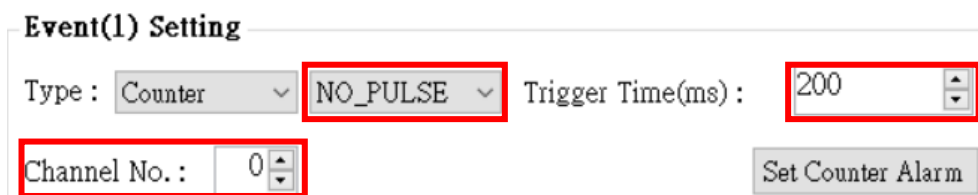

Figure 6.10.24

G. Click the Set Counter Alarm button as shown in Figure 6.10.25. Enter the Set Counter Alarm parameter. "Set Value" is "0" and "Alarm Value" is "10". As shown in Figure 5.20, press the "Set Value" button.



Figure 6.10.25

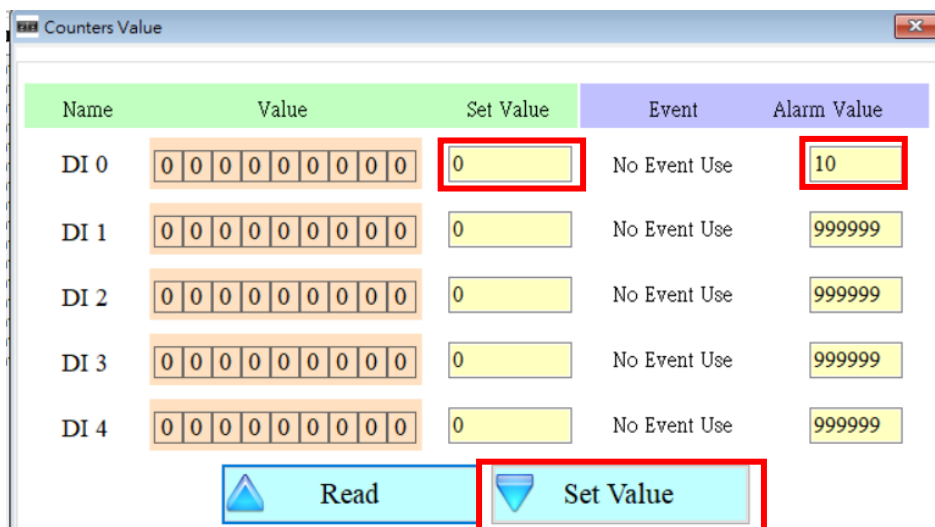

Figure 6.10.26

H. Fill in the target phone number, as shown in Figure 6.10.27

Phone List :

PhoneNumber
0912345678

Figure 6.10.27

I. Select the alert message content encoding method and fill in the alert message content as shown in Figure 6.20.28

MSG Mode :  7-Bit     UCS2

MSG Content :

Counter\_Test測試

Figure 6.10.28

J. Select the setting for DO when triggering the alarm, Ch select “ALL DO ON” to turn on DO0 and DO1, and Hold Time (ms) to select “6000” ms to let DO turn on after 6 seconds, as shown in Figure 6.10.29

DO Triggered

Ch. : ALL DO ON ▾

Holding Time(ms) :

6000 ▾

Figure 6.10.29

K. After setting, select “SAVE” to save as shown in Figure 6.10.30. Complete the list below and the setting will be displayed

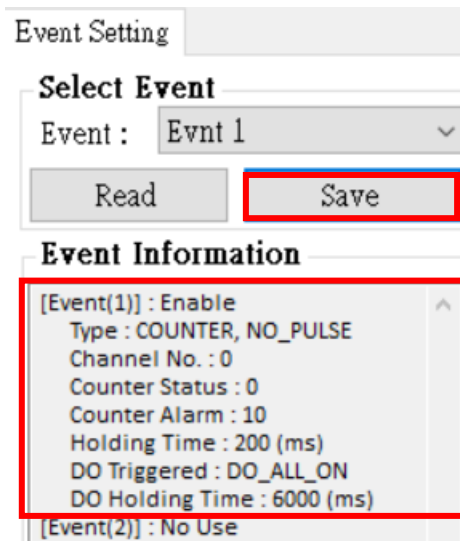

Figure 6.10.30

L. After finishing the selection, click “Write to Device”. As shown in Figure 6.10.31, write the settings to GTP-541M. At this time, the confirmation window will pop up and click OK. As shown in Figure 6.10.32, the parameters will be written. After the data is completed, the success window will pop up as shown in Figure 6.10.33

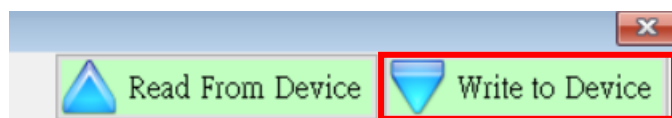

Figure 6.10.31

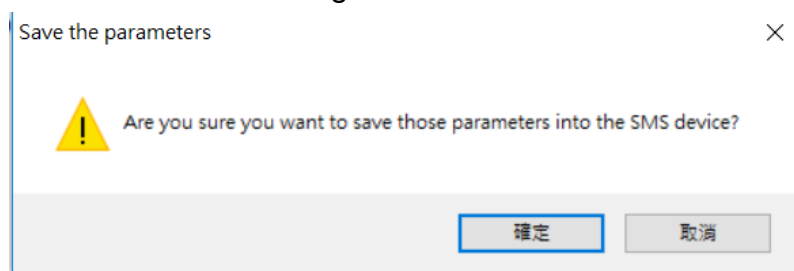

Figure 6.10.32

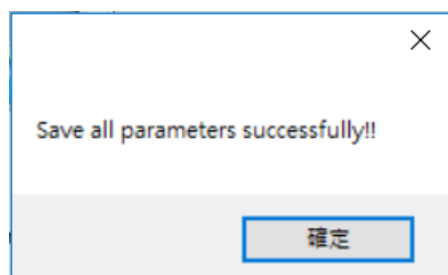

Figure 6.10.33

N. Pull the 4th pin and the 5th pin on the GTP-541M to connect as shown in Figure 6.10.34, and restart GTP-541M.

COM Port and Power Input		
Pin		Description
Frame Ground	1	F.G
Power Input : +10V <sub>DC</sub> ~ +30V <sub>DC</sub>	2	P.GND
	3	PWR
Init.	4	GND
	5	Init.
COM 1 RS-485	6	D-
	7	D+
COM 1 Utility Port RS-232	8	GND
	9	RxD
	10	TxD

Figure 6.10.34

M. After confirming that the STA light starts to flash normally, input the trigger signal to DI0 for 10 times, then the incoming mobile phone will receive the alarm message.

## 7. RMV Utility main screen description

The GTP-541M Utility interface mainly includes the following parts, as explained below:

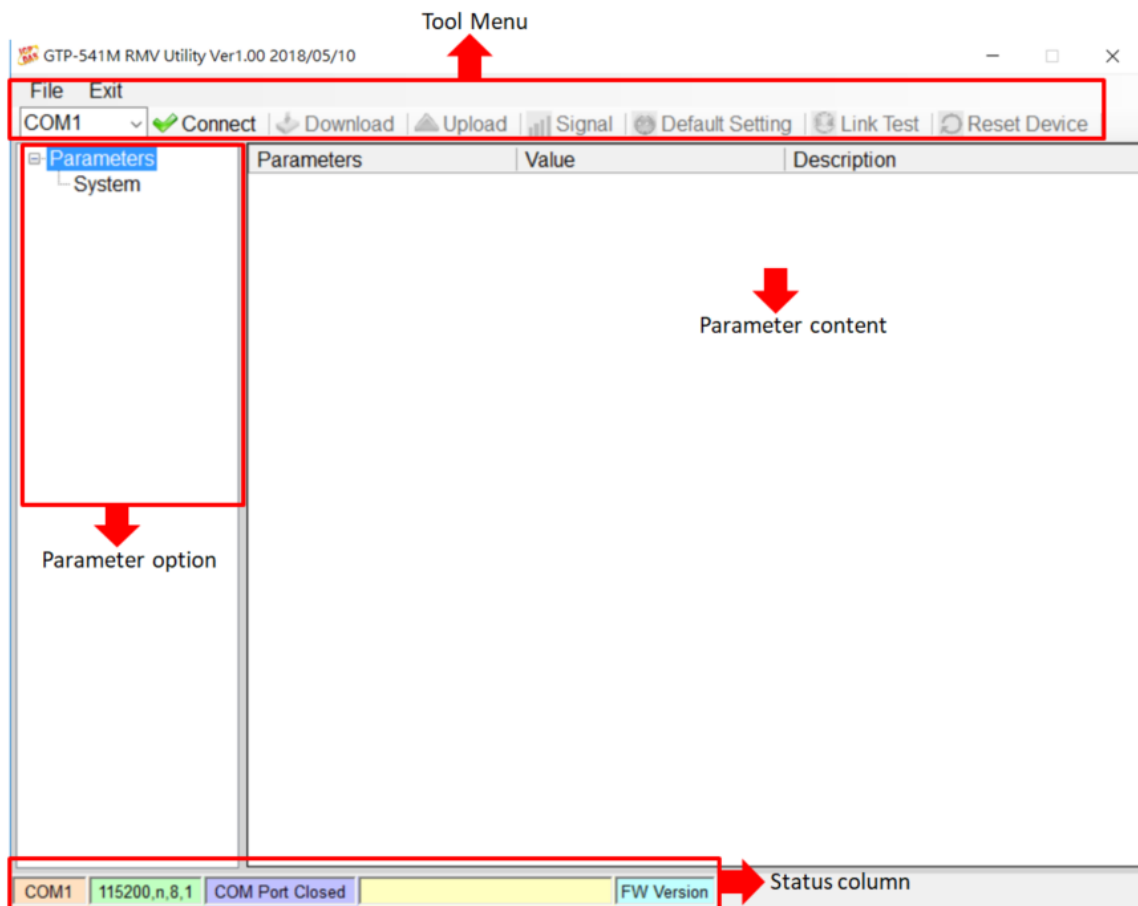

### 1. Toolbar

Toolbar options, including all the main function operations of the GTP-541M Utility, as described below :

- (1)File: The parameters of SMSRMV are stored in the form of a Project file. This operation includes:
  - "Import Parameters", "Export Parameters" .
- (2)Exit: Leaving GTP-541M Utility .
- (3)COM Port: No.: PC end COM Port number connected to GTP-541M .
- (4)Connect: Connect with GTP-541M .
- (5)Download: Download parameters to GTP-541M .
- (6)Upload: Upload the parameters of GTP-541M to GTP-541M Utility.
- (7)Signal: Query signal strength and network status.

(8) Default Setting: Reply to factory settings

(9) Link Test: Connection test

2. Parameter option:

Parameter options for GTP-541M, including: "System" and "COM Port".

3. Parameter content:

Display and change the contents of the parameters.

4. Status column:

Display current GTP-541M Utility related information, from left to right, in order:

(1) PC end COM Port number used by Utility .

(2) COM Port transmission settings .

(3) Current status of COM Port .

(4) Current operating status of the device .

(5) Firmware version.



## 7.1 Parameter File Management

Through the Project option, parameters can be saved into files or open parameter files, etc., and multiple GTP-541M parameters can be conveniently managed. The options are as follows:

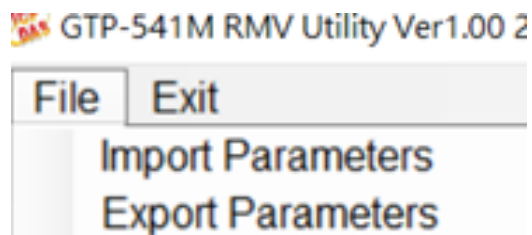

(1) Import Parameters: Open an existing parameter file to connect to GTP-541M.

(2) Export Parameters: Save the parameter as another file name.

## 7.2 Connection GTP-541M

GTP-541M can be connected by the following operations

1. Select the COM Port number of RS-232 / RS-485, as shown in Figure 7.2.1.

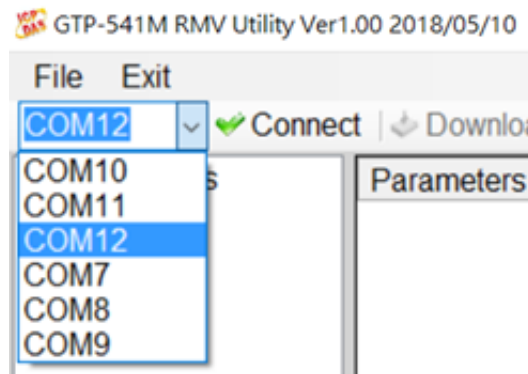

Figure 7.2.1

2. Press the “Connect” button to connect with the GTP-541M, as shown in Figure 7.2.2. If the cable fails, check if the RS-232/RS-485 Comport of the GTP-541M and the PC cable are selected correctly. Is the RS-232 / RS-485 line normal or whether the Init 4th and 5th pins are connected, as shown in Figure 7.2.3.

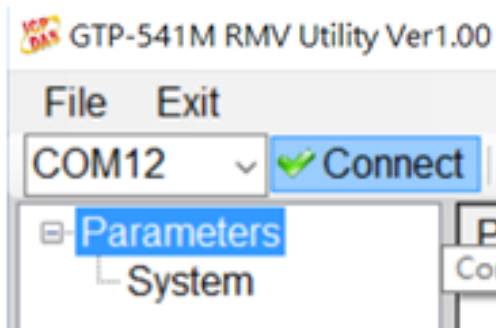

Figure 7.2.2

COM Port and Power Input		
Pin		Description
Frame Ground	1	F.G
Power Input : +10V <sub>DC</sub> ~ +30V <sub>DC</sub>	2	P.GND
	3	PWR
Init.	4	GND
	5	Init.
COM 1 RS-485	6	D-
	7	D+
COM 1 Utility Port RS-232	8	GND
	9	RxD
	10	TxD

Figure 7.2.3

## 7.3 Parameter Description

Click on the left window, the tree parameter option, the right side will display the parameter content in the parameter option, select the content you want to change, you can modify it, as shown in Figure 7.3.1 below.

Parameters	Value	Description
Server IP	192.168.127.1	
Server Port	11000	
Heartbeat Time	10	
Device ID	1	Unique ID for device, and it will ...
Alias	GTP-541	Max. length=8
Time Interval	50	1~5000 ms, default=50
Data Length	1000	10~1000 bytes, default=1000
TCP to RTU	1	default=0
PIN code	1234	default=1234 , Max Len=4
APN	INTERNET	Max Len = 63
Modem User		Max Len = 31
Modem Password		Max Len = 31
Com1		
ComPort baudrate	115200	baudrate = 2400 ~ 115200
ComPort Data Bit	8	Data Bit = 7 ~ 8
ComPort Parity Bit	none	Parity = none,odd,even
ComPort Stop Bit	1	Stop Bit = 1 ~ 2

Figure 7.3.1

### 7.3.1 Description of System Parameters

The "System" parameters, including 12 items :

parameter name	Description
Server IP	Remote Server IP
Server Port	Remote Server Port

Heartbeat Time	Heartbeat packet (range 10 seconds ~ 65535 seconds)
Device ID	Address ID of GTP-541M
Alias	Module alias (maximum length 8 words)
Time Interval	Interval (ms)
Data Length	Data length
TCP to RTU	Whether to enable TCP to RTU
PIN Code	SIM card unlock PIN code
APN	Internet APN
Modem User	Internet account
Modem Password	Internet password
ComPort Baudrate	Transmit bits per second, supporting 2400, 4800, 9600, 19200, 38400, 57600, and 115200bps
ComPort Data Bit	Data bit, support 7 or 8 bits
ComPort Parity Bit	Peer check, support for none, even and odd
ComPort Stop Bit	Stop bit, support 1 bit and 2 bits

## 7.4 Download and upload parameters

### 1. Download parameters

After the parameter setting is completed, you can download the parameters to the GTP-541M through this operation, as shown in Figure 7.4.1, click the “Download” button

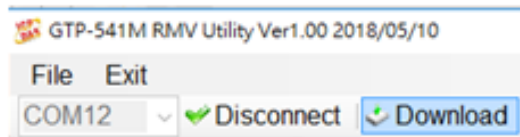

Figure 7.4.1

### 2. Upload parameters

This operation can be used when the parameters in the GTP-541M need to be extracted, as shown in Figure 7.4.2, click the “Upload” button.



Figure 7.4.2

## 7.5 Query signal strength

Click “Signal” to query the signal strength of the target GTP-541M. The sequence of steps is shown in Figure 7.5.1~7.5.2.

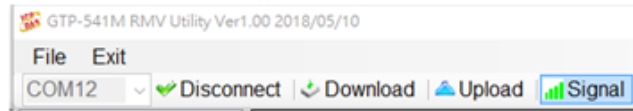

Figure 7.5.1

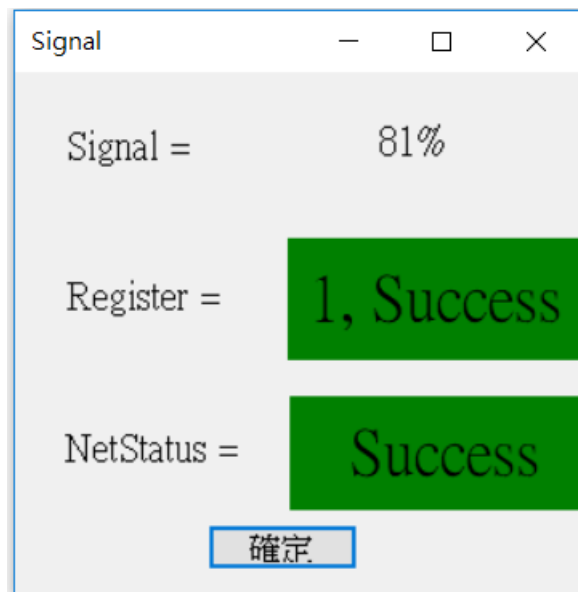

Figure 7.5.2

Field description :

- A. Register: The signal strength is expressed as a percentage ,, and the current intensity state is displayed in red and green.
- B. NetStatus: Shows the current connection status as red and green, and shows success and failure in color.

## 7.6 Back to factory defaults

After clicking “Default Setting”, click “Yes” to return the parameter to the factory default value. Click “No” to cancel the original factory default. The sequence is shown in Figure 7.6.1~7.6.2

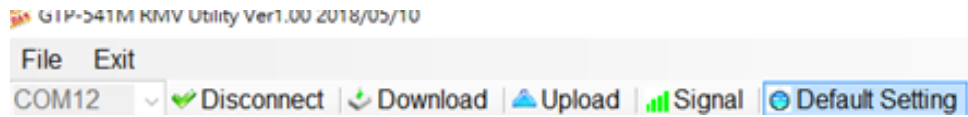

Figure 7.6.1

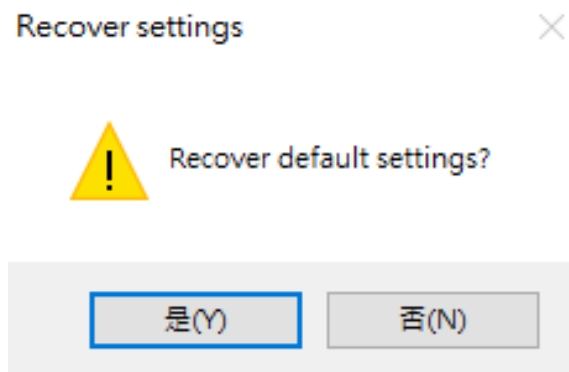

Figure 7.6.2

## 7.7 connection test

After clicking "Link Test", wait for 6 seconds to get the result of connecting to the test server. The sequence of steps is as follows Figure 7.7.1~7.7.3

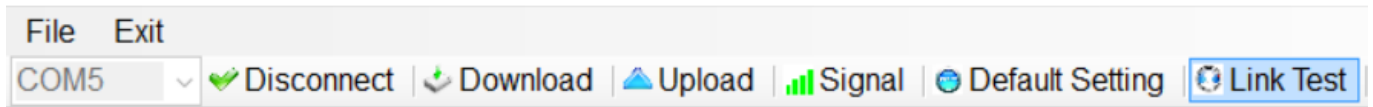

Figure 7.7.1

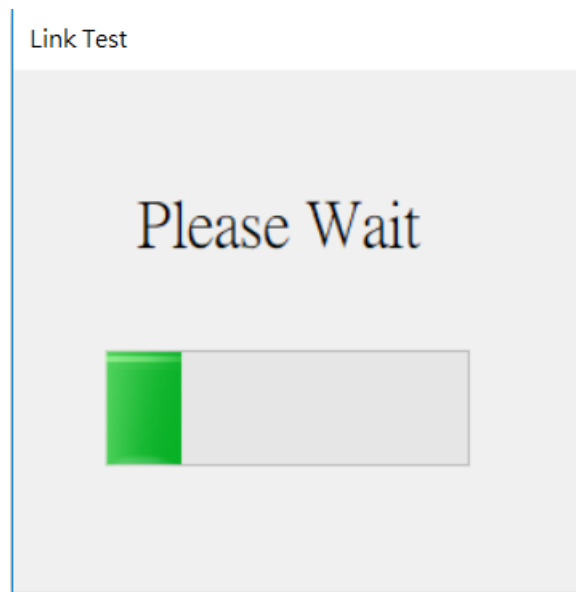

Figure 7.7.2

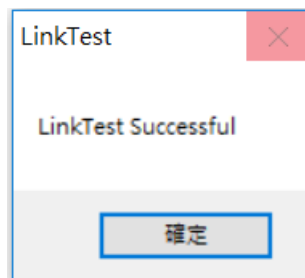

Figure 7.7.3



## 7.8 Restart

Click the “Reset Device” button. After 5 seconds, the GTP-541M will restart. The sequence of actions is shown in Figure 7.8.1~7.8.3



Figure 7.8.1

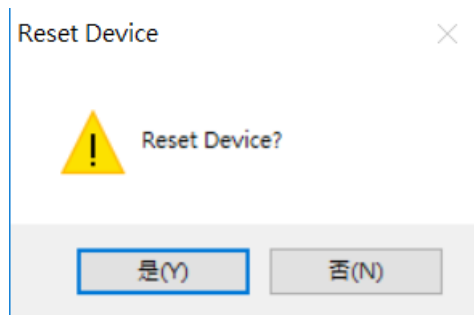

Figure 7.8.2

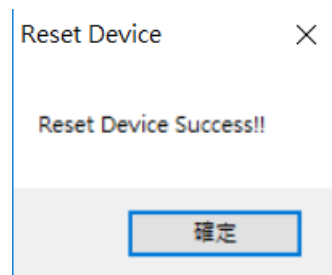
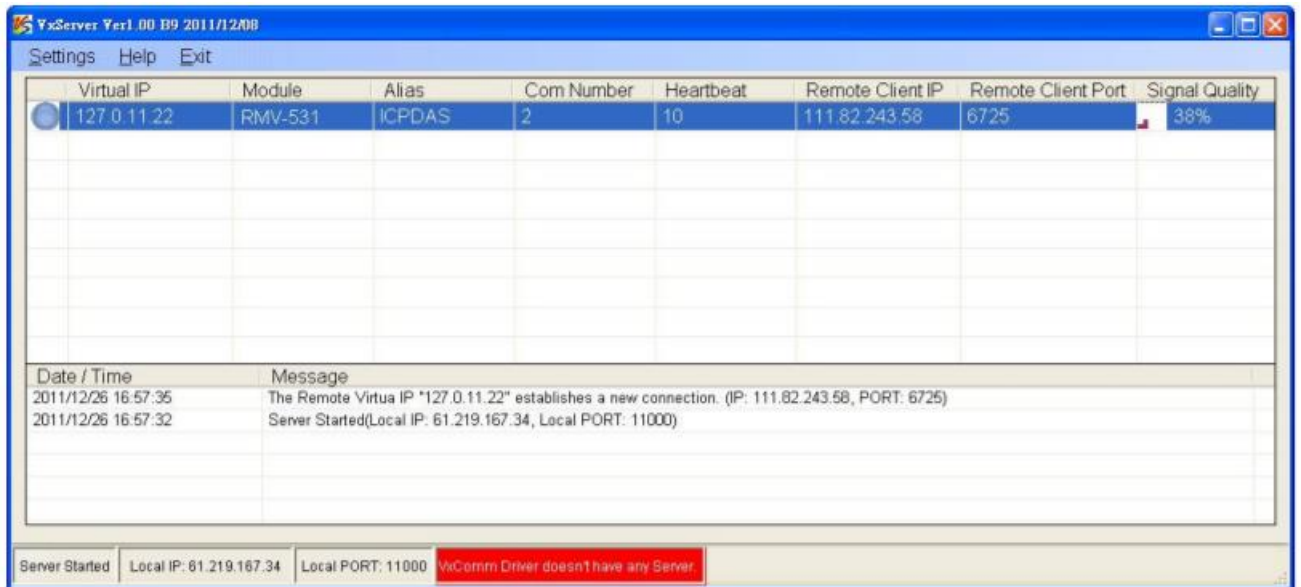

Figure 7.8.3

## 7.9 Setting VxServer and VxComm Driver

1. Confirm that the device is connected to the server.



2. Execute the VxComm Utility and click on "Search Servers".

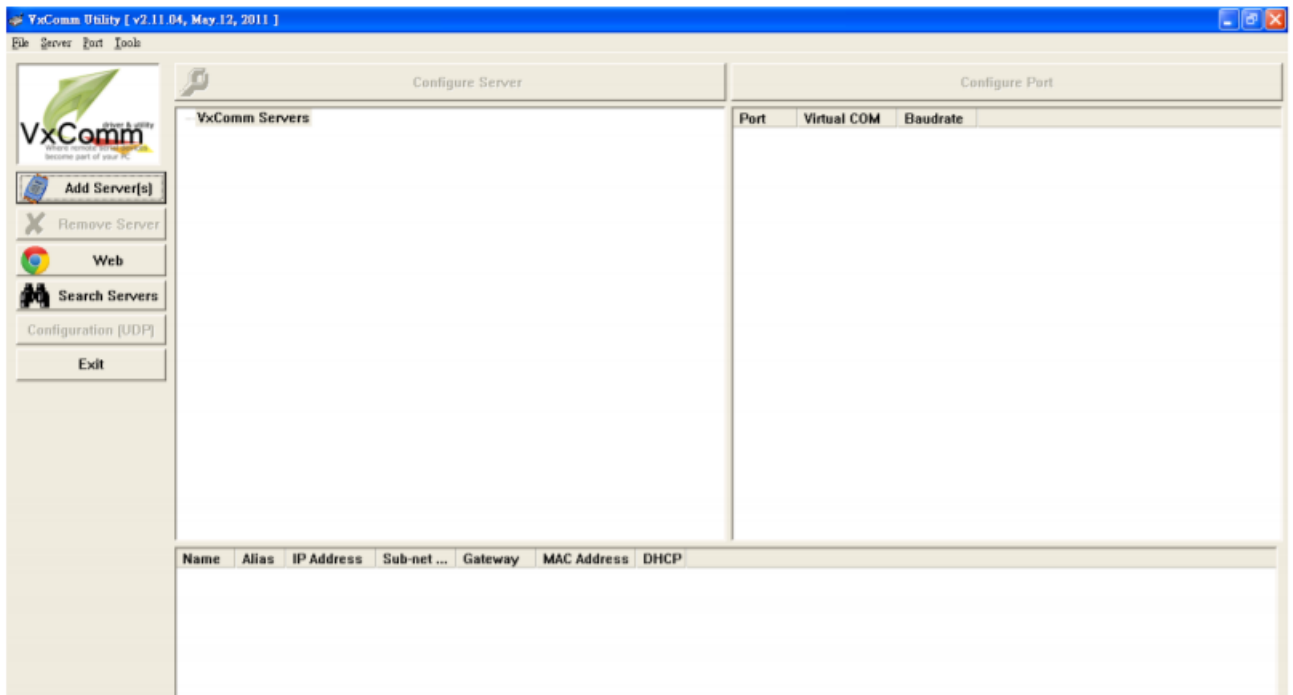

3. Select the device you want to join and click on "Add Server(s)".

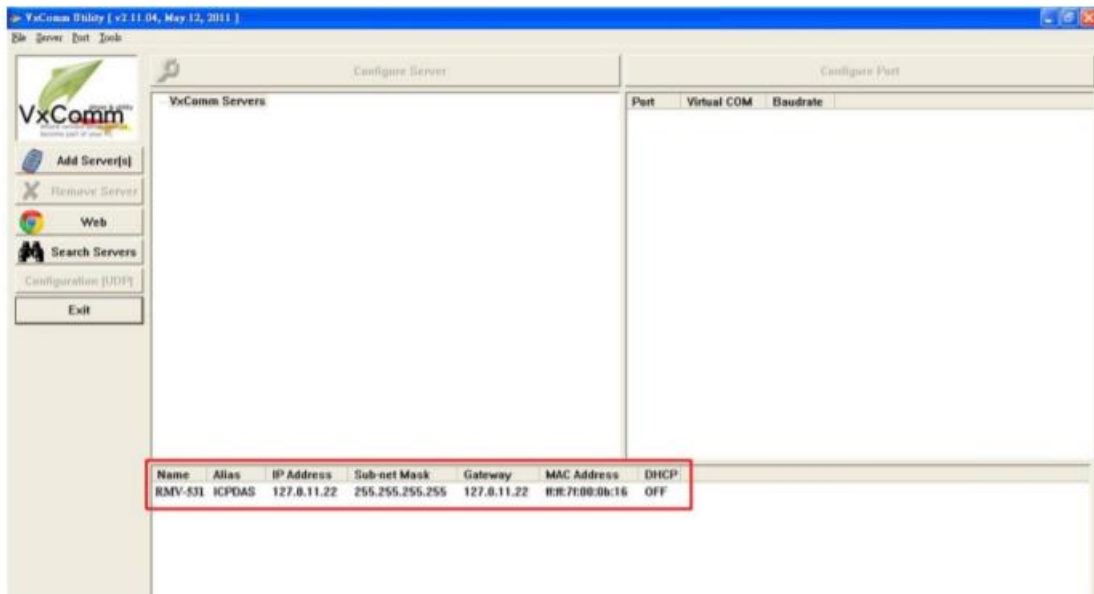

4. IP Range check "Maps virtual COM ports to "Port I/O" on servers".

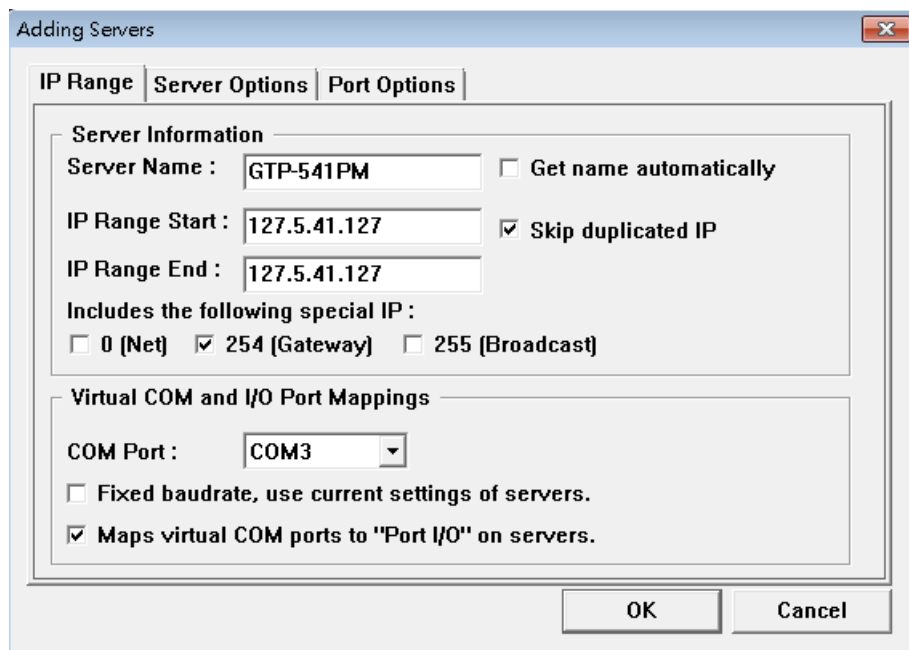

5. Server Options, please follow the parameter settings below.

参数	固定数值
Keep Alive Time	1
Connection Broken	3
Connect Timeout	1
Command Port	10000
Virtual I/O Port	9999

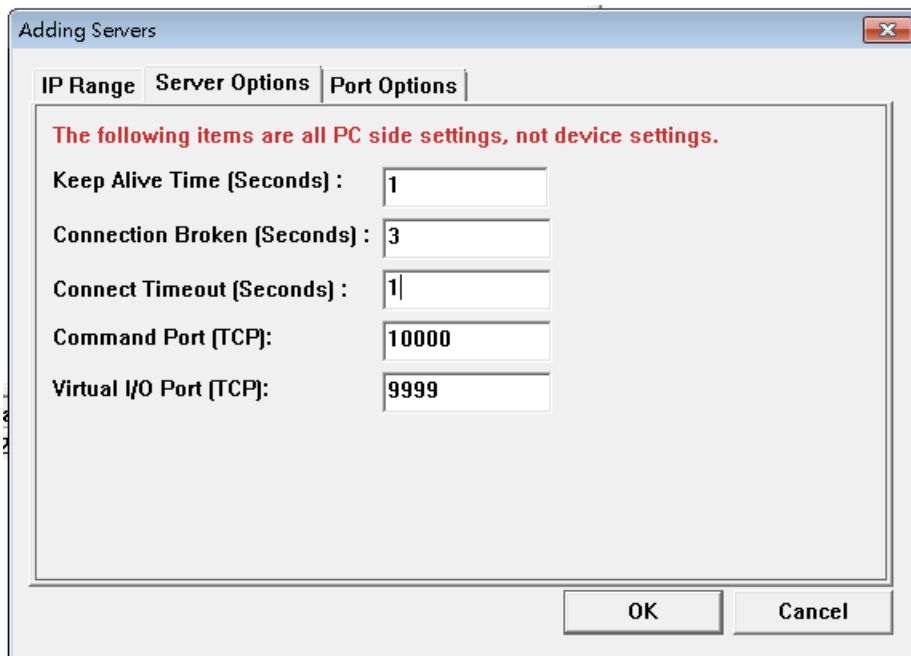

6. Tools Restart Driver.

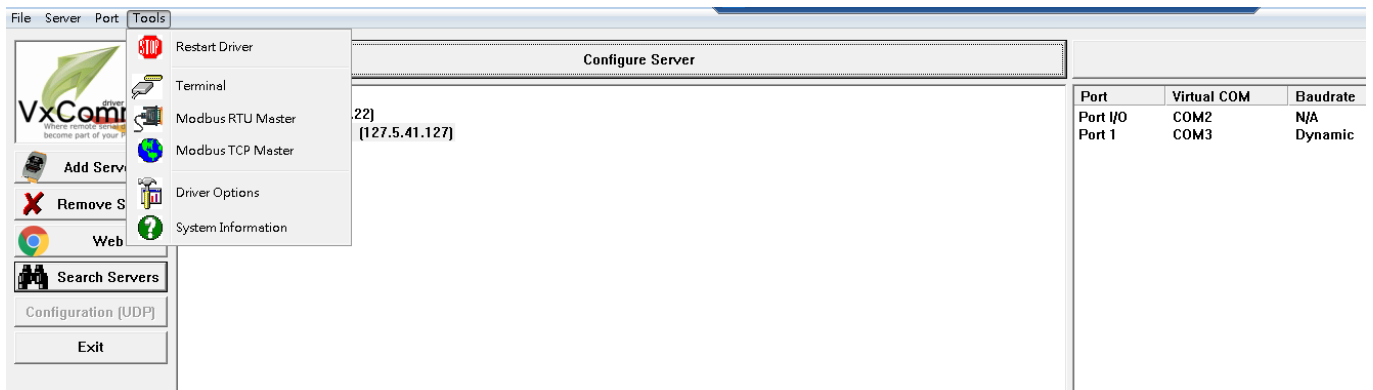

7. Click “Restart Driver” .

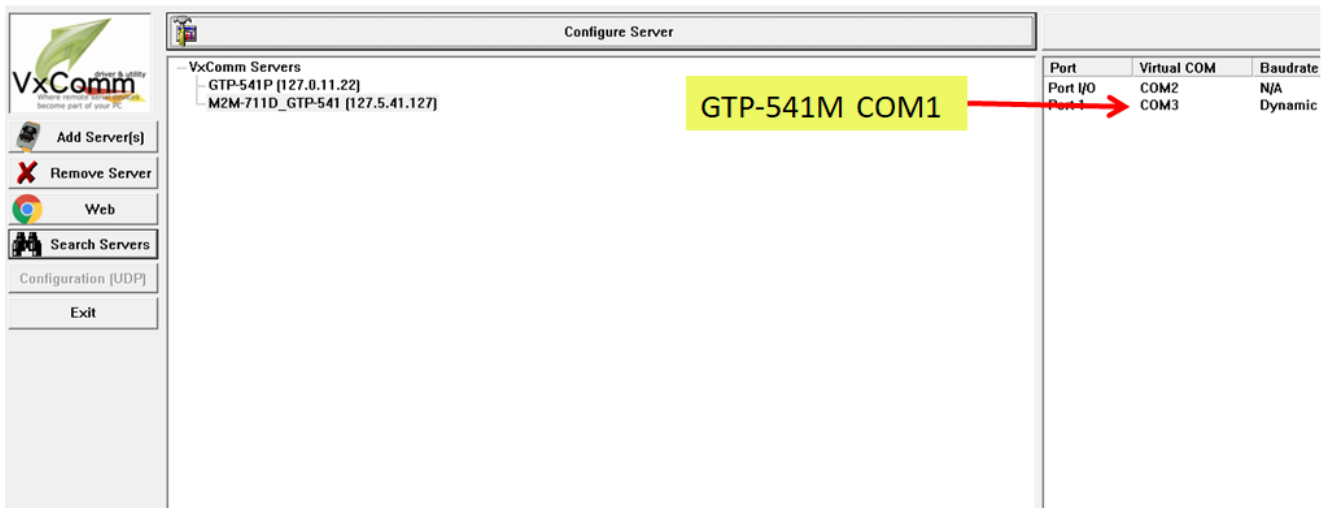
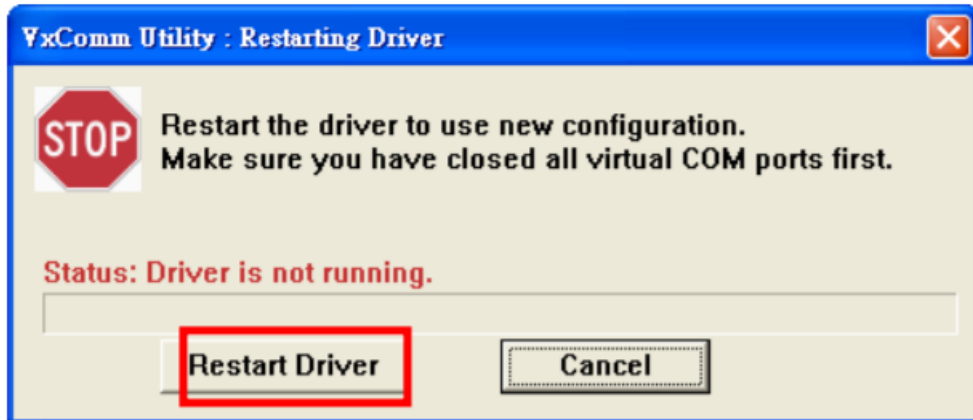

8. Select Com port according to Port I/O, click "Uart Utility" "Connect".

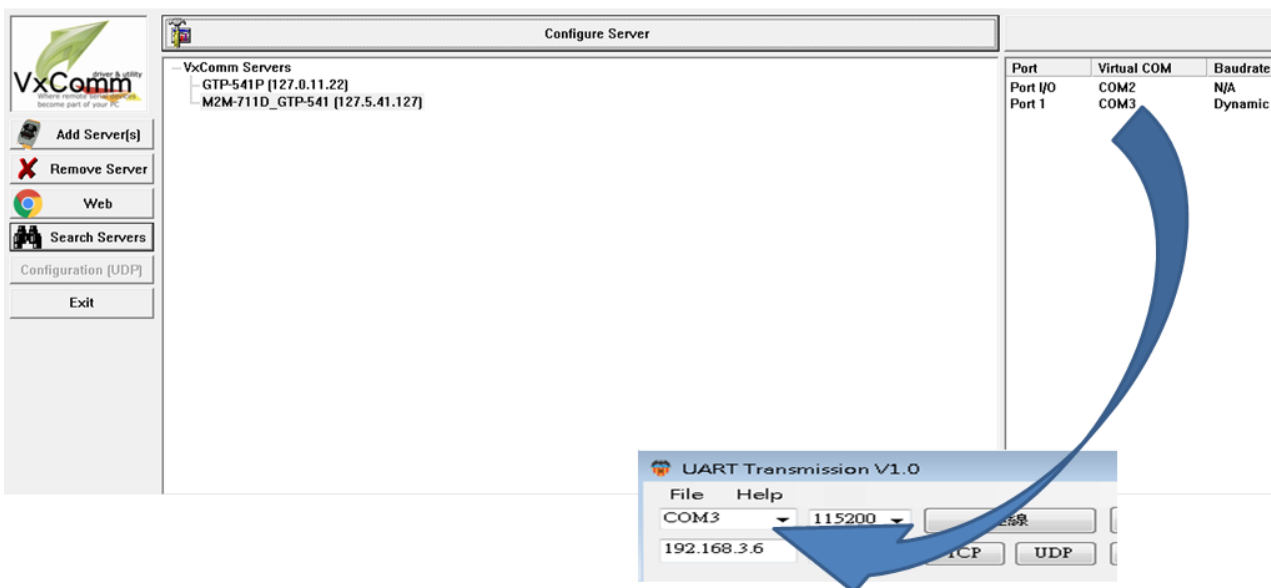

## 7.10 Virtual COM Connection Example

—、GTP-541M is connected to Utility.

A. Confirm whether the 4th Pin and the 5th Pin of GTP-541M are connected, as shown in Figure 7.10.1

COM Port and Power Input		
Pin		Description
Frame Ground	1	F.G
Power Input : +10V <sub>DC</sub> ~ +30V <sub>DC</sub>	2	P.GND
	3	PWR
Init.	4	GND
	5	Init.
COM 1 RS-485	6	D-
	7	D+
COM 1 Utility Port RS-232	8	GND
	9	RxD
	10	TxD

Figure 7.10.1

B. Click “Connect” on the Utility screen. As shown in Figure 7.10.2, if the connection is successful, “Connect success” will pop up and the “Connect” button will become “Disconnect”, as shown in Figure 7.10.3 and Figure 7.10.4.

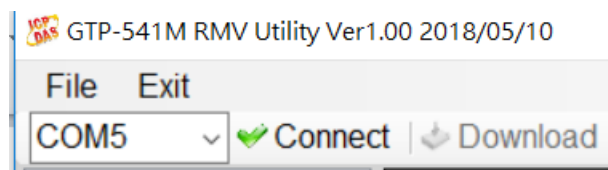

Figure 7.10.2

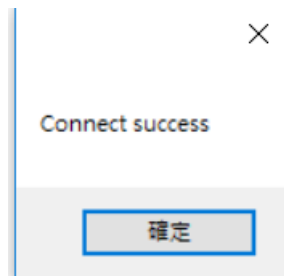

Figure 7.10.3

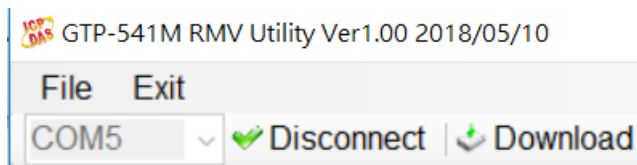

Figure 7.10.4

C. System parameter setting screen is shown in Figure 7.10.5. After setting the relevant parameters, press “Download” to write the parameter setting to GTP-541M as shown in Figure 7.10.6. After the writing is completed, the “Download to the device success” window will pop up. Figure 7.10.7

**Note 1:** If the SIM card is not set to Pin code, this column can be kept at the default value.

**Note 2:** For related parameter functions, please refer to pages 78 ~ 79.

Parameters	Value	Description
Server IP	125.227.224.161	
Server Port	11000	
Heartbeat Time	10	
Device ID	127	Unique ID for device, and it will ...
Alias	GTP-541M	Max. length=8
Time Interval	50	1~5000 ms, default=50
Data Length	1000	10~1000 bytes, default=1000
TCP to RTU	0	default=0
PIN code	1234	default=1234 , Max Len=4
APN	INTERNET	Max Len = 63
Modem User		Max Len = 31
Modem Password		Max Len = 31
Com1		
ComPort baudrate	115200	baudrate = 2400 ~ 115200
ComPort Data Bit	8	Data Bit = 7 ~ 8
ComPort Parity Bit	none	Parity = none,odd,even
ComPort Stop Bit	1	Stop Bit = 1 ~ 2

Figure 7.10.5

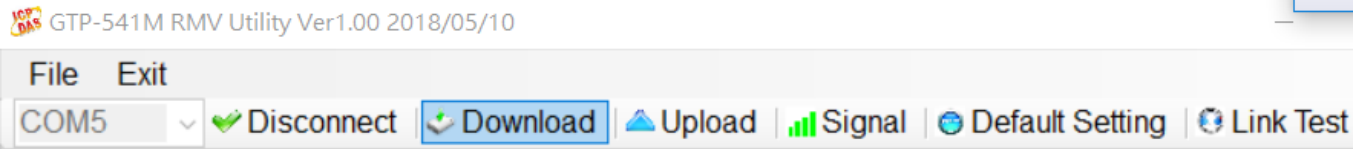

Figure 7.10.6

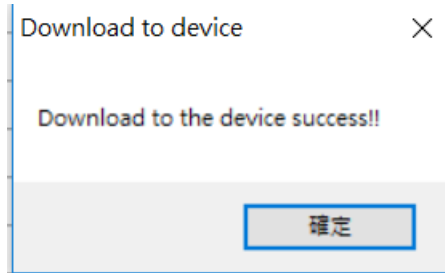

Figure 7.10.7

D. After the Utility setting is completed and written to the GTP-541M, confirm whether the 4th Pin and the 5th Pin of the GTP-541M have been removed as shown in Figure 7.10.8, and restart the GTP-541M.

COM Port and Power Input		
Pin		Description
Frame Ground	1	F.G
Power Input : +10V <sub>DC</sub> ~ +30V <sub>DC</sub>	2	P.GND
	3	PWR
Init.	4	GND
	5	Init.
COM 1 RS-485	6	D-
	7	D+
COM 1 Utility Port RS-232	8	GND
	9	RxD
	10	TxD

Figure 7.10.8

E. Server side open VxServer.exe as shown in Figure 7.10.9. After opening, it will show the items that GTP-541M has been connected to (if it does not appear immediately, please wait a moment), as shown in Figure 7.10.10, if GTP-541M has not appeared in List, please confirm whether Local IP and Local Port are the set Server IP and Server Port.

**Note 1: Server IP must be a fixed IP**





Figure 7.10.9

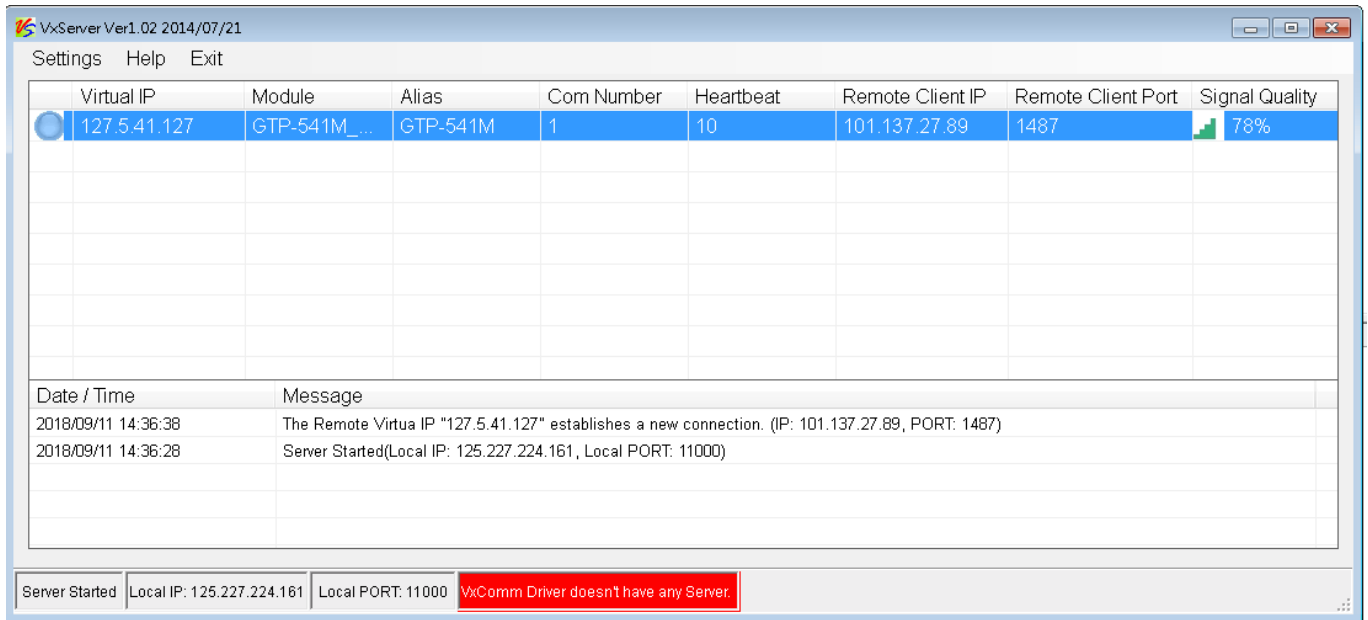

Figure 7.10.10

F.Open VxComm Utility.exe as shown in Figure 7.10.11. After opening, click “Search Servers” on the left side of the VxComm screen as shown in Figure 7.10.12, and confirm whether the GTP-541M appears in the list below the VxComm screen as shown in Figure 7.10.13.



Figure 7.10.11

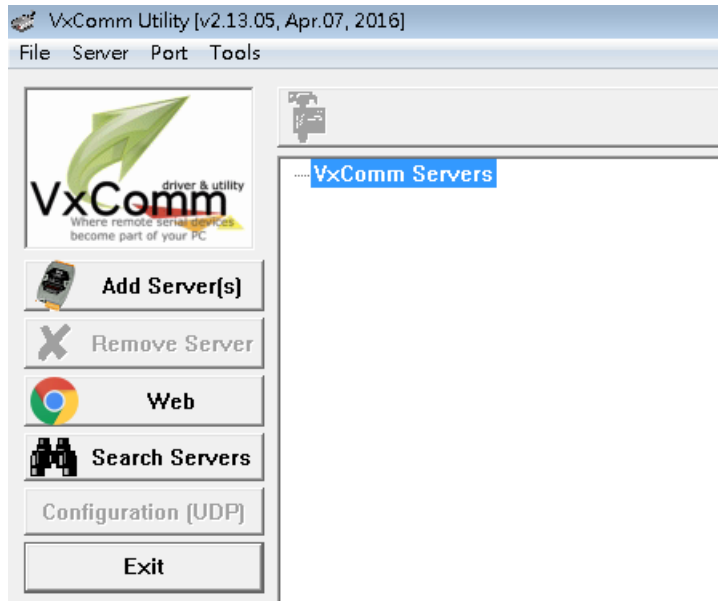

Figure 7.10.12

Name	Alias	IP Address	Sub-net Mask	Gateway	MAC Address	DHCP
GTP-541M_RMV	GTP-541M	127.5.41.127	255.255.255.255	127.5.41.127	ff:ff:7f:05:29:7f	OFF

Figure 7.10.13

G.Right click on GTP-541M and select “Add Server” as shown in Figure 7.10.14. After clicking, the Adding Servers window will appear as shown in Figure 7.10.15. In this window, select “COM Port” in the Virtual COM and I/O Port Mappings block. And "check below" Maps virtual COM ports to "Port I/O" on servers.

Name	Alias	IP Address	Sub-net Mask	Gateway	MAC Address	DHCP
GTP-541M_RMV	GTP-541M	127.5.41.127	255.255.255.255	127.5.41.127	ff:ff:7f:05:29:7f	OFF

	Ping Server
	Diagnostic
	Configure Server (UDP)
	Add Server(s)

Figure 7.10.14

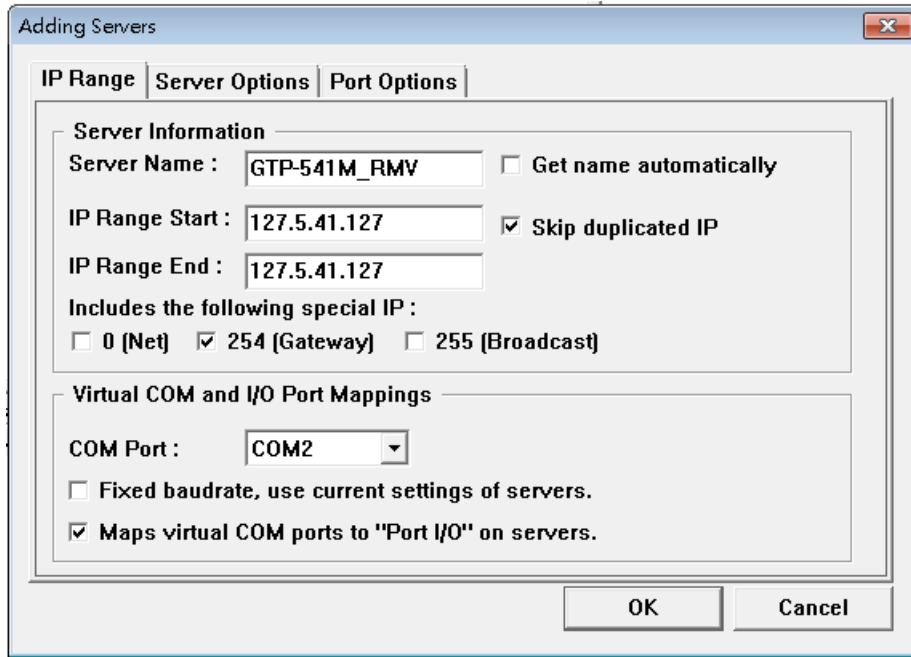

Figure 7.10.15

H. Then click on the Server Options at the top of the window and follow the screen setting parameters as shown in Figure 7.10.16. After setting, select "OK".

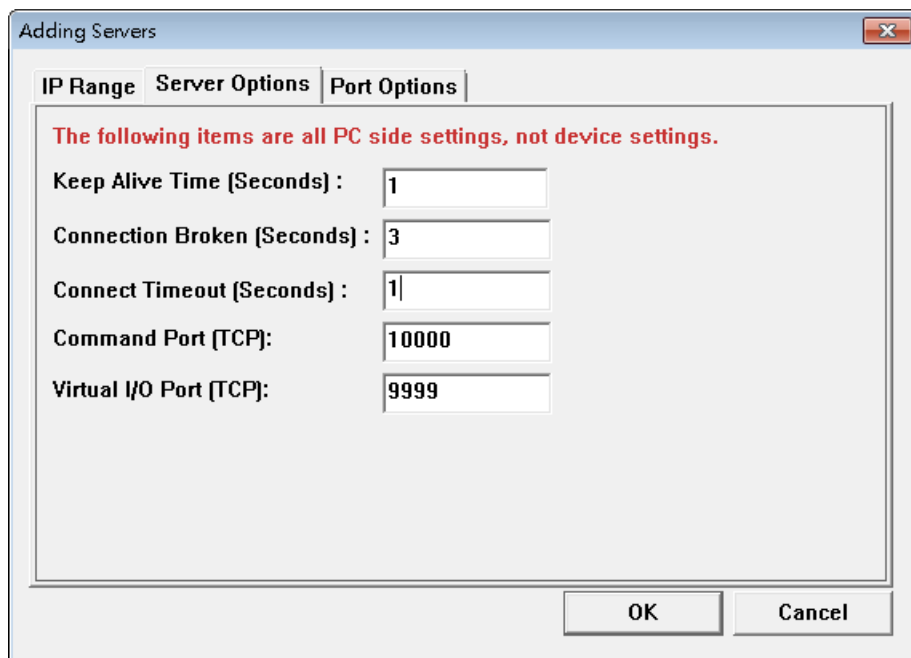

Figure 7.10.16

I. Upon completion, VxComm Servers will have the name of GTP-541M, and the right block will also appear ComPort is shown in Figure 7.10.17 ◦



Figure 7.10.17

J. After the setting is completed, click the “Restart Driver” update status in the upper left toolbar “Tools” as shown in Figure 7.10.18. At this time, “VxComm Driver is running” will be displayed at the bottom of the VxServer screen as shown in Figure 7.10.19. ◦

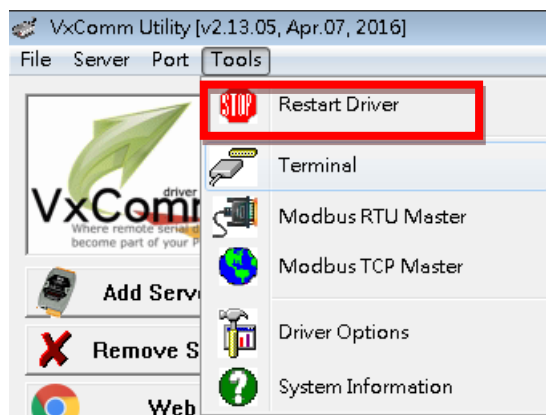

Figure 7.10.18

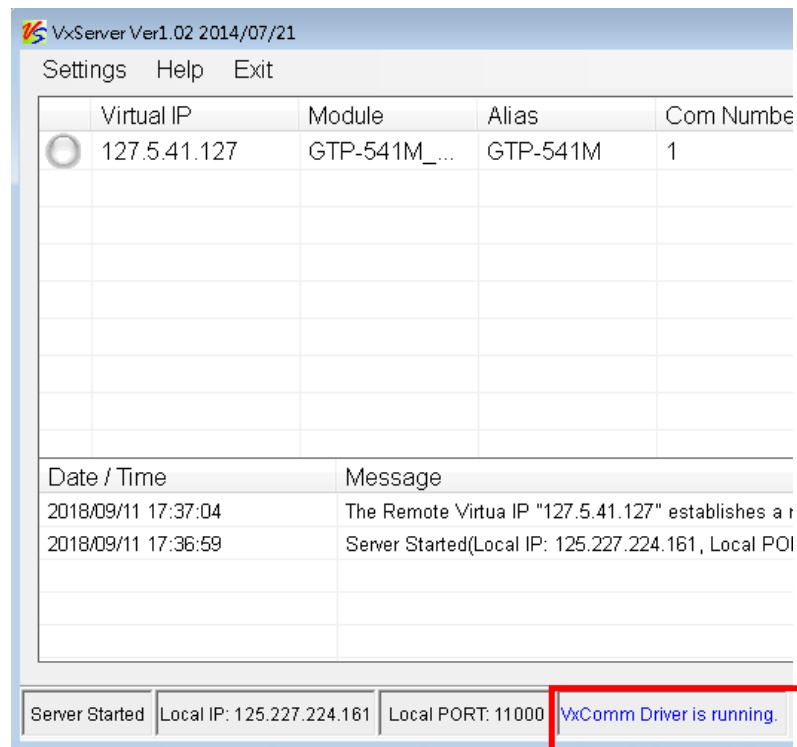

Figure 7.10.19

K. Open the Uart Utility program and select the Virtual COM number of Port1 as shown in Figure 7.10.20 and Figure 7.10.12

Port	Virtual COM	Baudrate
Port I/O	COM2	N/A
Port 1	COM3	Dynamic
Port 2	COM4	Dynamic

Figure 7.10.20

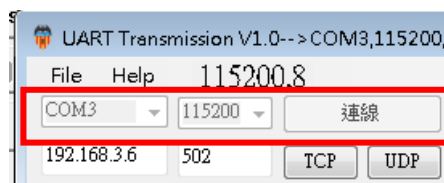

Figure 7.10.21

L. After opening Uart Utility on the PC side and selecting Virtual COM, connect the PC to RS-232/RS-485 on the GTP-541M side and open the Uart Utility to select the ComPort number of RS-232/RS-485. Data and confirm that the other side can receive normally, as shown in Figure 7.10.22

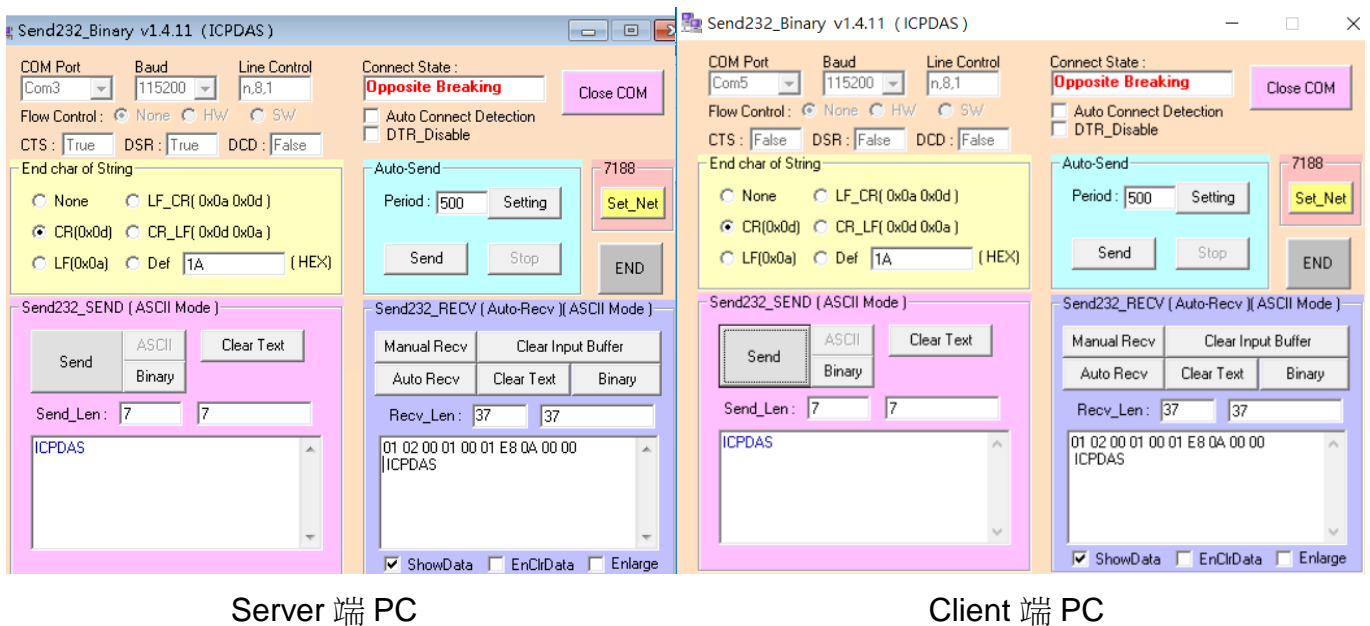
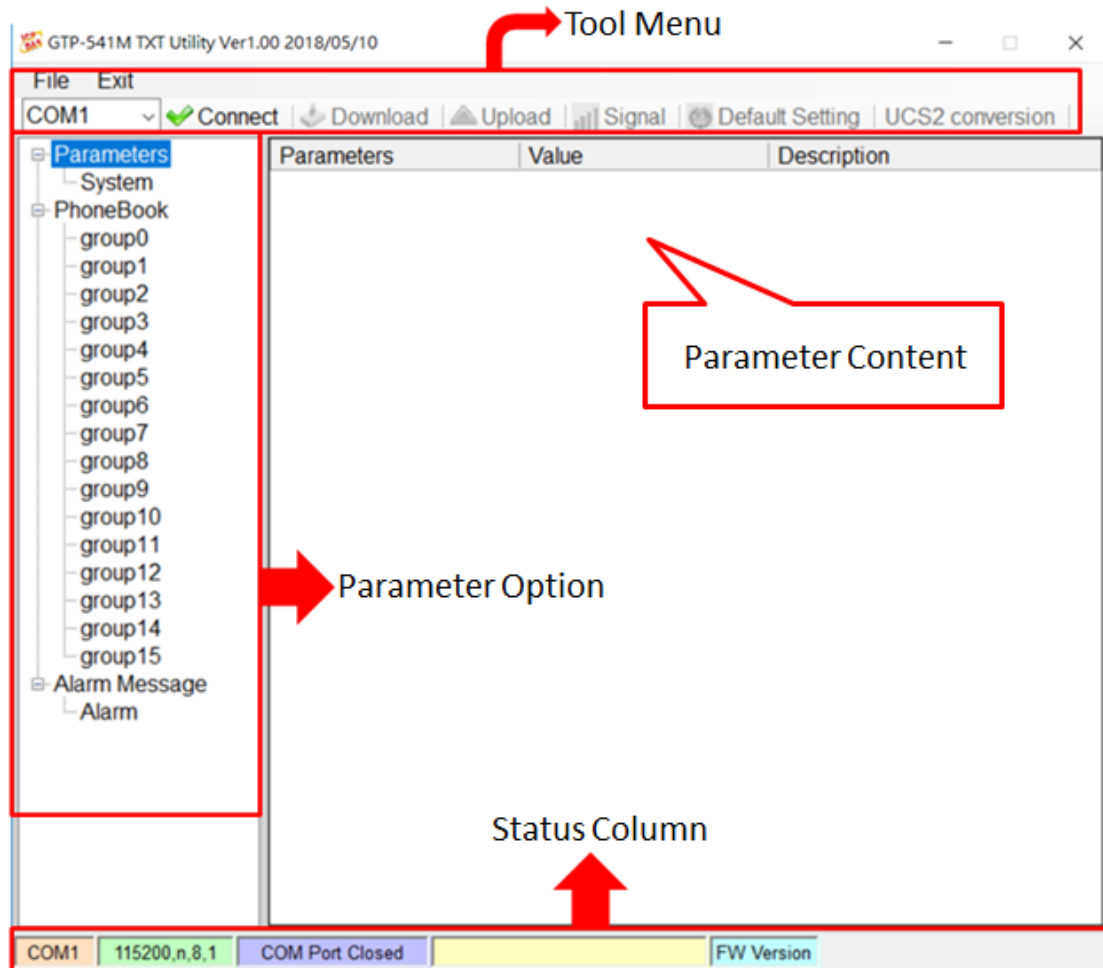

Figure 7.10.22

## 8. TXTSMS Utility main screen description



### 1. Tool Menu:

- ◆ File:  
Store and read the Prj parameter file.
- ◆ Exit:  
Leave the Utility.
- ◆ COM Port:  
PC-side ComPort number connected to GTP-541M.
- ◆ Connect:  
The Utility is connected to the GTP-541M.
- ◆ Download:  
Download the parameters to the GTP-541M.

- ◆ Upload:  
Read the parameter data of GTP-541M to Utility.
- ◆ Signal:  
Read the current signal strength.
- ◆ Default Setting:  
Restore the data to the factory-set parameters.
- ◆ UCS2 Conversion:  
A tool that converts input strings to Unicode.

## 2. Parameter Option

- ◆ GTP-541M's parameter options are divided into 3 categories, including "System", "PhoneBook" and "Alarm Message".

## 3. Parameter Content

- ◆ A table showing the parameters that can be changed.

## 4. Status Column

- ◆ Display details of the GTP-541M Utility operation, from left to right, in order:
  - A. The COM port number of the PC used by the Utility.
  - B. ComPort transmission settings.
  - C. The current state of ComPort.
  - D. Utility action results.
  - E. Firmware version of GTP-541M.

## 8.1 Parameter File Management

The File option can be used to save parameters into files or open parameter files. It is convenient to manage multiple GTP-541M parameters. The options are as follows:

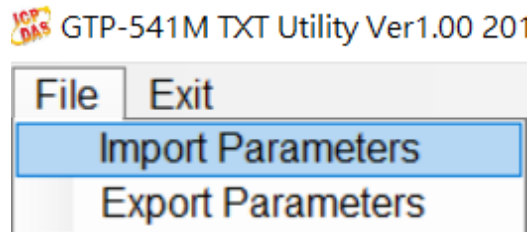

**A.Import Parameters:**

Read the Prj file and fill in the relevant parameters into the Utility.

**B.Export Parameters:**

Export the parameter file Prj file



## 8.2 Description of parameter options

Click on the left window, the tree parameter option, the right side will display the parameter content in the parameter option, select the content you want to change, you can modify it, as shown below:

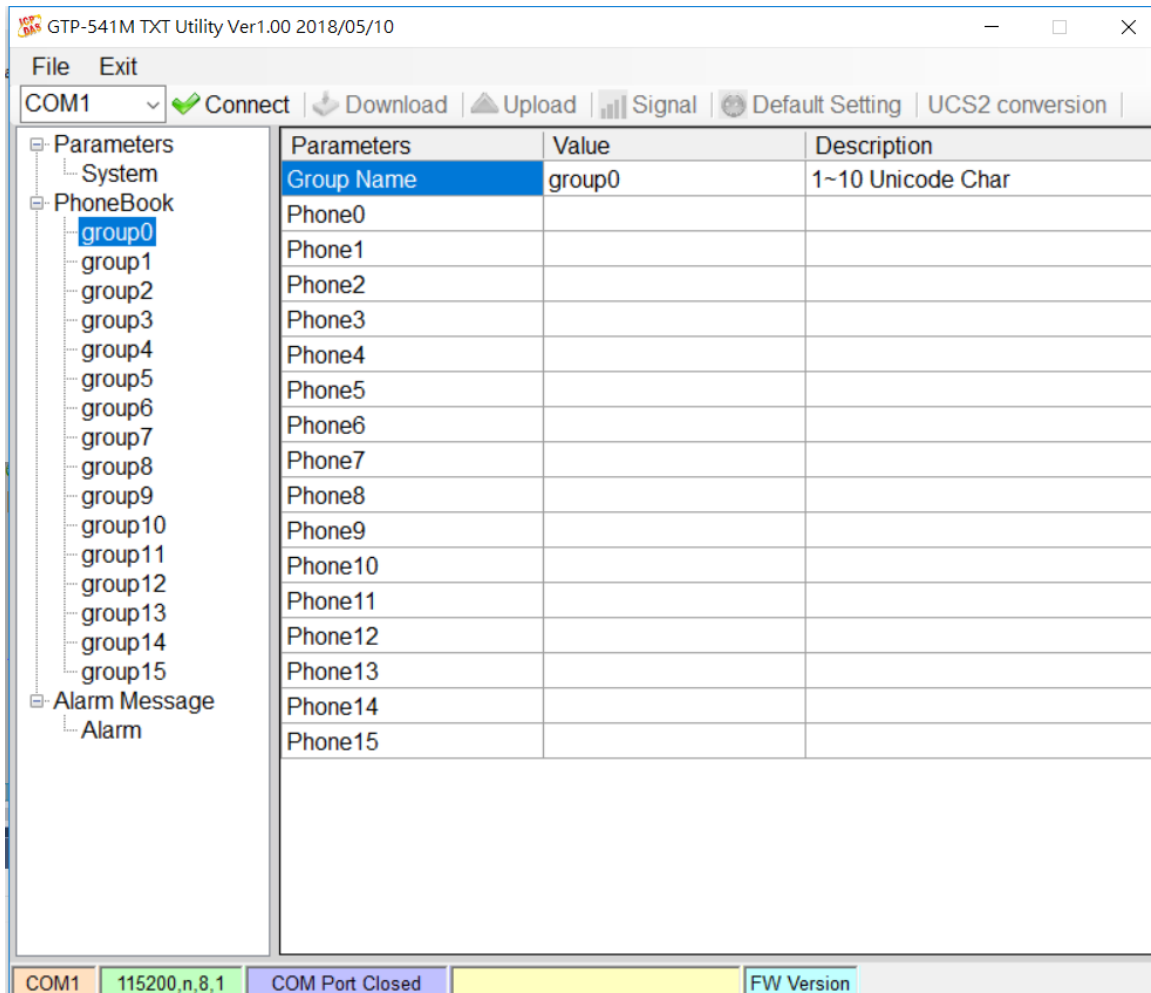

### 8.2.1 Description of System Parameters

The "System" parameters, including 5 items, are:

Parameters	Value	Description
PIN code	1234	default=1234 , Max Len=4
Com1		
ComPort baudrate	115200	baudrate = 2400 ~ 115200
ComPort Data Bit	8	Data Bit = 7 ~ 8
ComPort Parity Bit	none	Parity = none,odd,even
ComPort Stop Bit	1	Stop Bit = 1 ~ 2

A. PIN Code:

If you have a password when registering your SIM card, you can use this code to unlock it. If you do not need to unlock it, you will not use this item.

B. ComPort baudrate:

Set Com1's transmission bits per second to support 2400, 4800, 9600, 38400, and 115200bps.

C. ComPort Data Bit:

Set the data bit of Com1 to support 7~8 bits.

D. ComPort Parity Bit:

Set the E1 check of Com1 to support none, even (even) and odd (odd).

E. ComPort Stop Bit:

Set the stop bit of Com1 to support 1 and 2 bits.

### 8.2.2 Phone Book Parameter Description

The "Phone Book" parameter is used to define the phone group number and the phone number in the category group. The description is as follows:

A. Modify the group name:

After adding a phone group, to change the group name, first click on the group name in the left windows, then go to the right windows (Group Name) to change, as shown below:

<ul style="list-style-type: none"> <li>Parameters</li> <li>  System</li> <li>  PhoneBook</li> <li>    Phone1</li> <li>    group1</li> </ul>	<table border="1"> <thead> <tr> <th>Parameters</th> <th>Value</th> <th>Description</th> </tr> </thead> <tbody> <tr> <td>Group Name</td> <td>Phone1</td> <td>1~10 Unicode Char</td> </tr> <tr> <td>Phone0</td> <td></td> <td></td> </tr> <tr> <td>Phone1</td> <td></td> <td></td> </tr> </tbody> </table>	Parameters	Value	Description	Group Name	Phone1	1~10 Unicode Char	Phone0			Phone1		
Parameters	Value	Description											
Group Name	Phone1	1~10 Unicode Char											
Phone0													
Phone1													

B. Add, modify, or delete phone numbers in the group:

Click on the group name in the left window, then add, modify or delete the phone number in the right window. Each group can set up to 16 phone numbers.

<ul style="list-style-type: none"> <li>Parameters</li> <li>  System</li> <li>  PhoneBook</li> <li>    Phone1</li> <li>    group1</li> <li>    group2</li> </ul>	<table border="1"> <thead> <tr> <th>Parameters</th> <th>Value</th> <th>Description</th> </tr> </thead> <tbody> <tr> <td>Group Name</td> <td>Phone1</td> <td>1~10 Unicode Char</td> </tr> <tr> <td>Phone0</td> <td>0912345678</td> <td></td> </tr> <tr> <td>Phone1</td> <td>0923456789</td> <td></td> </tr> <tr> <td>Phone2</td> <td>0934567890</td> <td></td> </tr> </tbody> </table>	Parameters	Value	Description	Group Name	Phone1	1~10 Unicode Char	Phone0	0912345678		Phone1	0923456789		Phone2	0934567890	
Parameters	Value	Description														
Group Name	Phone1	1~10 Unicode Char														
Phone0	0912345678															
Phone1	0923456789															
Phone2	0934567890															

### 8.2.3 Alarm Message Parameter Description

The parameters of "Alarm Message" are used to define the content of the SMS and send the target phone group. The description is as follows:

<ul style="list-style-type: none"> <li>Parameters</li> <li>  System</li> <li>  PhoneBook</li> <li>    Phone1</li> <li>      group1</li> <li>      group2</li> <li>      group3</li> <li>      group4</li> <li>      group5</li> <li>      group6</li> <li>      group7</li> <li>      group8</li> <li>      group9</li> <li>      group10</li> <li>      group11</li> <li>      group12</li> <li>      group13</li> <li>      group14</li> <li>      group15</li> <li>  Alarm Message</li> <li>    Alarm</li> </ul>	Parameters	Value	Description
	Alarm Channel	0	Choose Alarm Number
	Alarm Message		
	Alarm Type	0	
	All group	<input type="checkbox"/>	
	group0	<input type="checkbox"/>	
	group1	<input type="checkbox"/>	
	group2	<input type="checkbox"/>	
	group3	<input type="checkbox"/>	
	group4	<input type="checkbox"/>	
	group5	<input type="checkbox"/>	
	group6	<input type="checkbox"/>	
	group7	<input type="checkbox"/>	
	group8	<input type="checkbox"/>	
	group9	<input type="checkbox"/>	
	group10	<input type="checkbox"/>	
	group11	<input type="checkbox"/>	
group12	<input type="checkbox"/>		
group13	<input type="checkbox"/>		
group14	<input type="checkbox"/>		
group15	<input type="checkbox"/>		

Parameter Name	Description
<b>Alarm Channel</b>	Alarm number, drop-down form, select 0~255
<b>Alarm Message</b>	When the input command triggers an alarm, the content of the sent message, the number of input words is divided according to the choice of Alarm Type: 1: UCS2 code 70 words. 0 : ASCII code 140 words.
<b>Alarm Type</b>	The format of the SMS encoding is divided into UCS2 and ASCII.
<b>All Group</b>	Check or cancel all phone groups.
<b>group0~group15</b>	After checked, when an alarm is triggered, an alert message is sent to the group of the choosed group.

## 8.3 Download and Upload Parameters

### A. Download:

After the parameter setting is completed, you can use this button to download the parameters to the GTP-541M Device, as shown below, click the “Download” button.

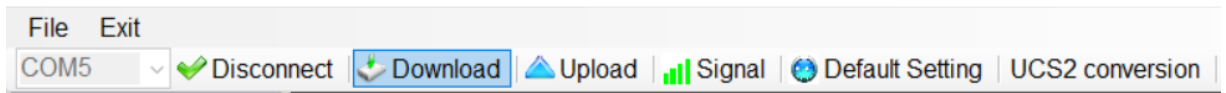

### B. Upload:

When you need to read the parameters in GTP-541M, you can use this button to read related data from GTP-541M Device, as shown below, click the “Upload” button.

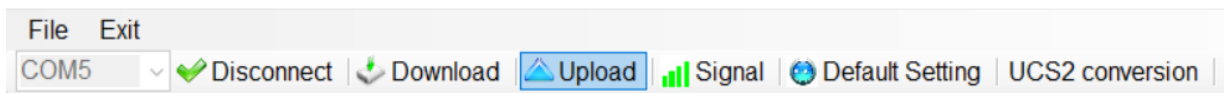

## 8.4 Query signal strength

Click the “Signal” button to query the current 4G signal strength of the GTP-541M.



A. Description of the field:

Signal: The percentage of signal strength.

Register: The SIM card registration status is successfully displayed in green, and the failure is displayed in red.

## 8.5 Back to factory defaults

After clicking “Default Setting”, click “Yes” to return the parameter to the factory default value. Click “No” to cancel the original factory default.

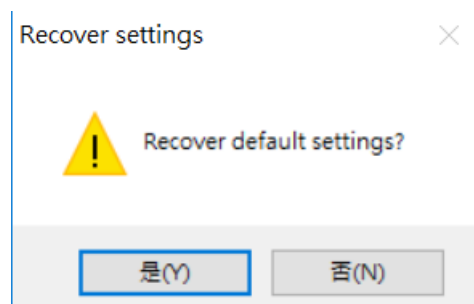
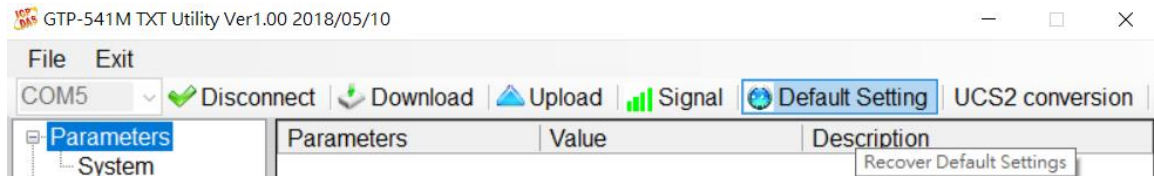

## 8.6 UCS2 Conversion Tool

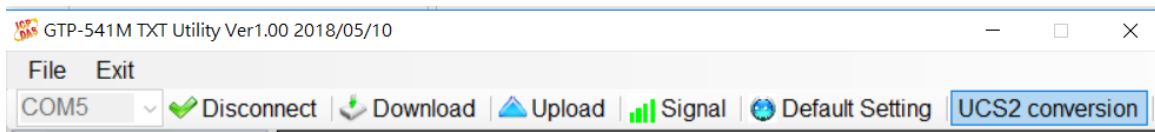

1. Click “UCS2 Conversion” to open the UCS2 conversion tool, as shown below.

2. Enter the content of the message in the upper field, and the converted Unicode code will be displayed in the lower field.

3. This code is for UCS2 newsletter content that is filled in when sending SMS messages dynamically.

## 8.7 SMS Command Description

Through the SMS command, you can send a dynamic message and a fixed message to the GTP-541M through the Comport command.

SMS instruction summary

SMS command	Description
@ALARM	Send fixed message
@SMSEND	Send dynamic ASCII message
@SMSENDUCS2	Send dynamic UCS2 message

### 8.7.1 @ALARM(Send fixed message)

#### (1)Description

The command is send fixed message.

#### (2)Request

Set Up:

`@ALARMn`

Field description:

n: ALARM number to send.

Example:

Send a fixed message ALARM1.

`@ALARM0`

#### (3)Response

Format:

`!ALARMn;OK`

Field description:

n: Specified Alarm number.

Example:

`!ALARM0;OK`



### 8.7.2 @SMSEND(Send Dynamic ASCII Message)

#### (1)Description

The command is send ASCII dynamic SMS.

#### (2)Request

Set Up:

```
@SMSEND=Phone;Message
```

Field Description:

Phone: Destination phone number to send.

Message: The content format of the message is 26 basic Latin letters, Arabic numerals and English punctuation marks, and the maximum number of words is 140.

Example:

Send ASCII dynamic message

```
@SMSEND=0912345678;ICPDAS_ASCII_TEST
```

#### (3)Request:

Receive ASCII SMS content:

```
ICPDAS_ASCII_TEST
```

Uart receive format:

```
!SMSEND;OK
```

Example:

```
!SMSEND;OK
```

### 8.7.3 @SMSENDUCS2(Send dynamic UCS2 Message)

#### (1)Description:

The command is send UCS2 dynamic SMS.

#### (2)Request:

Set Up:

```
@SMSENDUCS2=Phone;Message
```

Field description:

Phone: Destination phone number to send.

Message: SMS content format Unicode encoding, up to 70 words.

Example:

Send UCS2 dynamic SMS

```
@SMSENDUCS2=0912345678;00490043005000440041005300200055004300530032
```

(3)Response

Receive UCS2 SMS content:

```
!CPDAS UCS2
```

Uart receive format:

```
!SMSENDUCS2;OK
```

Example:

```
!SMSENDUCS2;OK
```

## 9. RTU Utility main screen description

The GTP-541M RTU Utility layout mainly includes the following parts, which are explained as follows:

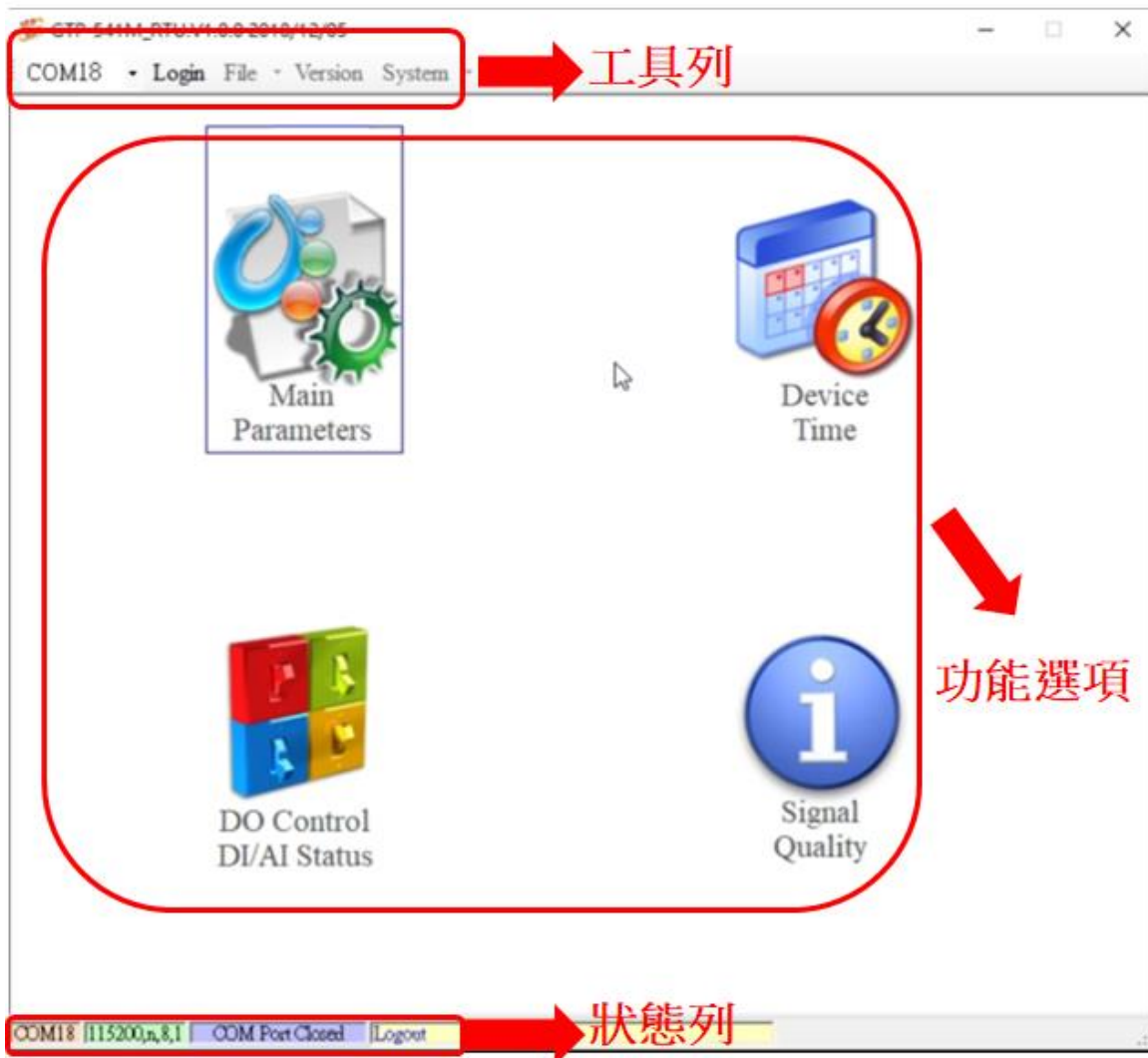

### Tool train

#### ◆COM :

Select PC COM PORT Connected to GTP-541M

#### ◆Login/Logout :

To do anything with GTP-541M, you must log in first. After successful login, the options will

become logout, and the options in Utility will allow the operation. If the newsletter reopens or shuts down the external power supply, it must be re-logged in.

◆Version :

GTP-541M Firmware and Utility Version Information.

◆System :

There are two functions: Recover to Factory Settings and Restart GTP-541M (Reset Device).

## Functional options

◆Main Parameter :

GTP-541 related settings.

◆Device Status:

Check SD Card, GPRS and GPS status.

◆Device Time :

Query and set the RTU-140 device time.

◆Signal Quality :

Query the signal strength of the current device.

## Status Bar

Display information about the operation of the GTP-541 Utility, from left to right, in order

(5)PC-side COM Port number used by the Utility.

(6)Transmission parameter setting of COM Port.

(7)The current connection status of the COM Port.

(8)The result of each operation, such as the success of the “storage” action.

## 9.1 主參數

Set the parameters and functions of the block, described in detail as follows:

### 9.1.1 Main Info Parameter Description

#### ◆ System Info

Parameters	Value	Discription
Machine Name	GTP-541-UDR	1~20 Char.
Data Logger Period(sec)	5	0~65535
Max. Time per Log File(min)	3	3~1440
Choose Mode	RTU	

Parameter name	Description
Machinie Name	Device name. In E-Mail mode, the E-Main content contains this information. (1 - 20 characters)

Data Logger Period(Sec)	In data records, the time interval of each record is in seconds. If it is 0, the function of I/O data record is turned off. (0 - 65535 seconds)
Max Time per Log File(Min)	The time of each record is divided into units. (3-1440 points)
Choose Mode	Select the function options to open, RTU, E-Mail and FTP3 functions to open alternatively ◦

◆ GPRS Info

The screenshot shows a software window titled "Main Parameters" with a tree view on the left and a table on the right. The tree view includes "Main Info" (System Info, GPRS Info, RTU Mode, E-Mail Mode, FTP Mode, RS485 Info) and "Modbus Device" (Custom, M-7016, M-7017C). The "GPRS Info" section is selected. The table below lists GPRS parameters:

Parameters	Value	Discription
GPRS APN	internet	0~31 Char.
GPRS User Name	guest	0~31 Char.
GPRS User Password	guest	0~31 Char.

At the bottom of the window, there are two buttons: "Read From Device" (with an upward-pointing triangle icon) and "Write to Device" (with a downward-pointing triangle icon).

Parameter name	Description
GPRS APN	The Access point name required to log in to the GPRS system is provided by the carrier who applied for the SIM card.  (0 ~ 31 char)
GPRS User Name	The account number required to log in to the GPRS system is provided by the carrier who applied for the SIM card.  (0 ~ 31 char)
GPRS User Password	The password required to log in to the GPRS system is provided by the carrier who applied for the SIM card.(0 ~ 31 char)

## ◆ RTU Mode

The screenshot shows a software window titled "Main Parameters" with a tree view on the left and a table of parameters on the right. The "RTU Mode" option is selected in the tree view. The table lists several parameters with their current values and descriptions.

Parameters	Value	Discription
Server IP	125.227.224.162	
Server Port	10000	0~65535
Machine ID	1	1~65535
Data Update Period(sec)	3	0~999999
Heartbeat Period(sec)	5	0~999999

At the bottom of the window, there are two buttons: "Read From Device" (with an upward-pointing triangle icon) and "Write to Device" (with a downward-pointing triangle icon).

Parameter name	Description
Server IP	IP position of server. In RTU mode, it refers to the remote PC that executes M2M RTU Center, and in E-Mail mode, it refers to the mail server. (0 - 31 characters)
Server Port	The network port number used by the server. In RTU mode, you need to specify 10000, in E-Mail mode, and 25 for general mail servers. (0 ~ 65535)
Machine ID	In RTU mode, the ID of the GTP-541M device. In the receiving software "M2M RTU Center" of the remote PC, the ID of the device must be added before the data uploaded by the device can be received. (1 ~ 65535)
Data Update Period(sec)	The time interval for uploading data is in seconds. If it is 0, this function is turned off.  (0-999999 seconds)
Heartbeat Period(sec)	The time interval for transmitting a heartbeat packet is to tell the remote PC that the device is still alive. (0-999999 seconds)



## ◆ E-Mail Mode

Parameters	Value	Discription
E-Mail Encryption	NONE	type
Server User Name		0~35 char.
Server User Password		0~35 char.
SMTP Server	(-CLR)	1~51 char.
SMTP Port	0	0~65535
E-Mail From	(-CLR)	1~51 char.
Receiver E-mail Address		
E-mail addr. 1		0~51 char.
E-mail addr. 2		0~51 char.
E-mail addr. 3		0~51 char.
E-mail addr. 4		0~51 char.
E-mail addr. 5		0~51 char.
E-mail addr. 6		0~51 char.
E-mail addr. 7		0~51 char.
E-mail addr. 8		0~51 char.
E-mail addr. 9		0~51 char.
E-mail addr. 10		0~51 char.

Read From Device      Write to Device

Parameter name	Description
E-Mail Encryption	<p>GTP-541M only supports the following three ways:</p> <ol style="list-style-type: none"> <li>1. NONE: No authentication is required.</li> <li>2. SSL: Log in to the mail server with the authentication of SSL.</li> <li>3. TLS: Log in to the mail server with TLS authentication.</li> </ol>

Server User Name	Log in to the mail server account. (0-35 characters)
Server Password	The password to log in to the mail server. (0-35 characters)
SMTP Server	IP location of SMTP. (0 - 51 characters)
SMTP Port	The network port number used by SMTP.
E-Mail From	Specify the sender of the e-mail. In E-Mail mode, this field cannot be empty.  (1 - 51 characters)
E-Mail Addr.1~ E-Mail Addr. 10	In E-Mail mode, these 10 fields can be used to specify the addresses of e-mail, currently supporting up to 10 locations. (0-51 characters)

◆ **FTP Mode**

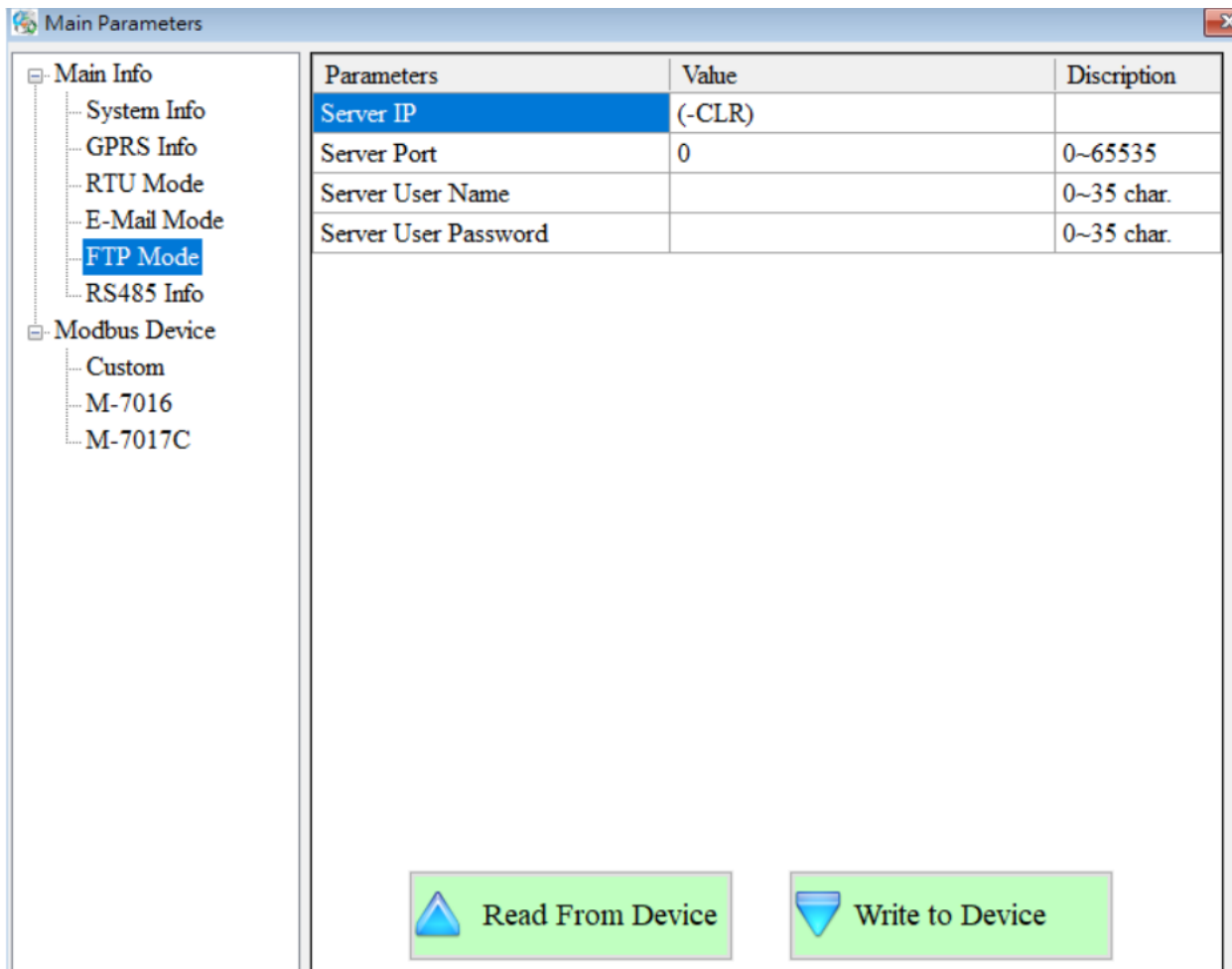

Parameter name	Description
Server IP	IP address of FTP.
Server Port	FTP's network port number.
Server User Name	FTP login account.
Server User Password	FTP login password.

## ◆ RS-485 Info

Parameters	Value	Discription
Baudrate	115200	
Data Bit	8	
Stop Bit	1	
Parity Bit	none	

Parameter name	Description
Baudrate	Transport Rate of ComPort
Data Bit	Data bits of ComPort
Stop Bit	Stop Bits of ComPort
Parity Bit	Specifies the method of peer checking. None: No check, odd: odd bit check, even: even bit check.

## Modbus Devices

GTP-541M can connect up to three Modbus RTU devices, Macro's M-8000 series products and other Modbus RTU devices. The number of I/O channels supported by each Modbus RTU device is as follows:

DI : 32 Channels

DO : 32 Channels

AI : 16 Channels

AO : 16 Channels

### 1. Add a new Modbus RTU device

To join a Modbus RTU device to the GTP-541, you can do the following:

- (1) Click on "Modbus Device" in the tree view and press the right mouse button.
- (2) Click on "Add Device"
- (3) Select the name of the Modbus RTU device. If it is not the M-8000 series produced by ICP DAS, please select "Custom".

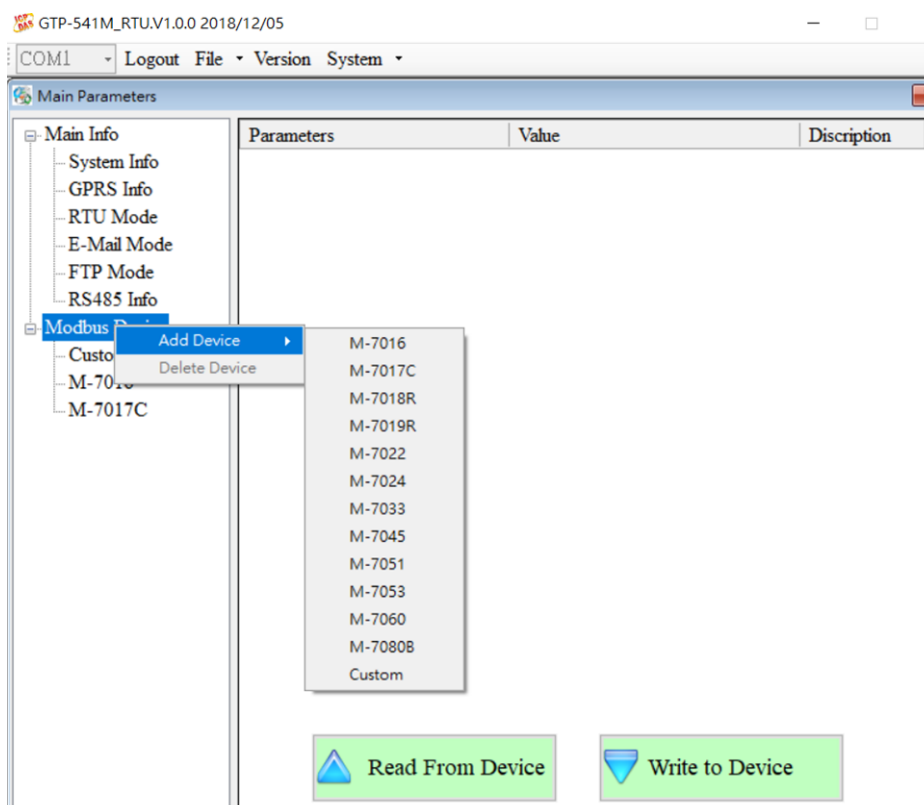

### 1. Remove a Modbus RTU device

To remove a Modbus RTU device from the GTP-541, you can do the following:

- (1) Click on the name of the Modbus RTU device you want to remove in the tree view

and press the right mouse button.

- (2) Click on "Delete Device" to complete the removal.

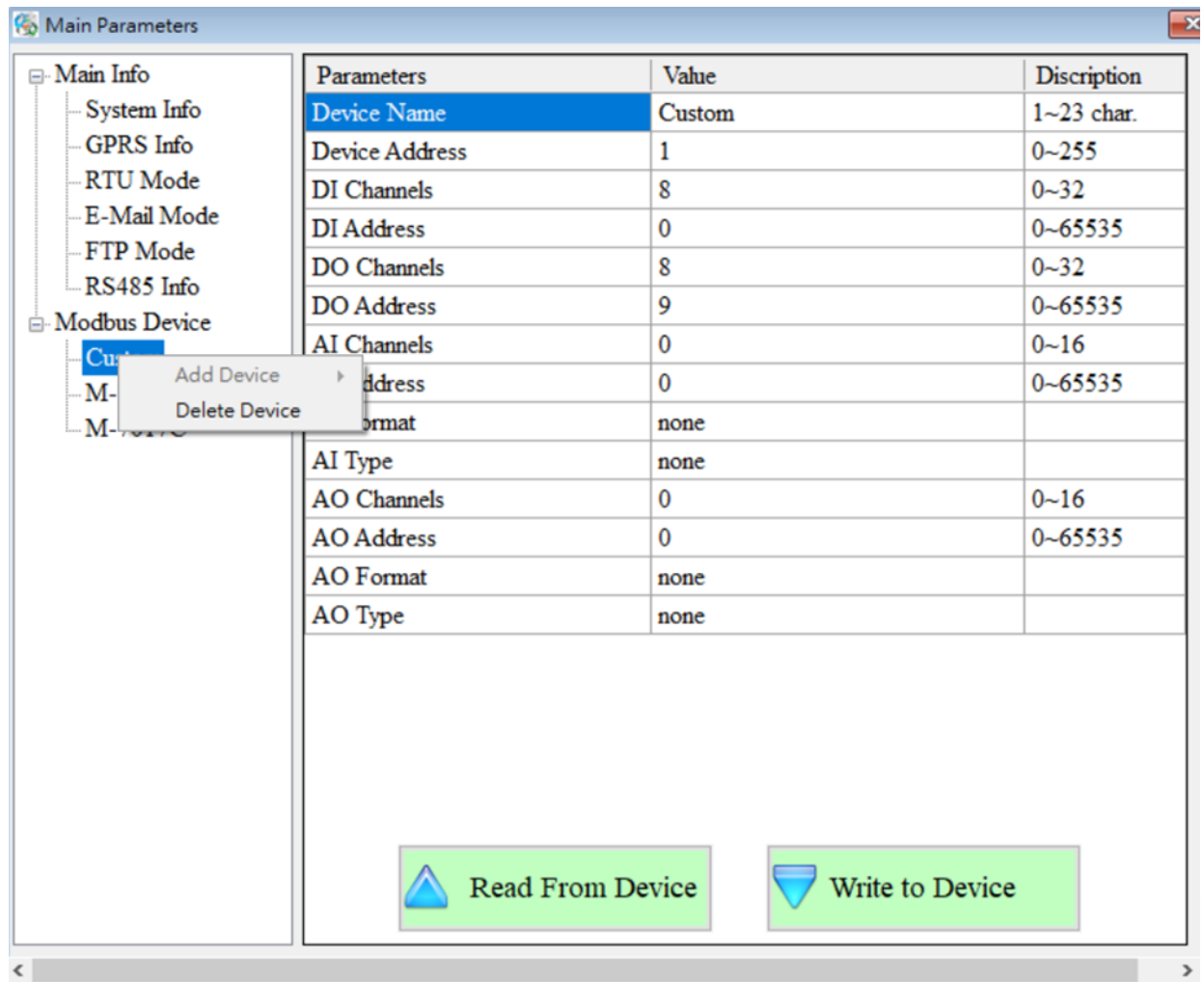

## 2. Parameter Description

Parameter name	Description
Device name	The name of the Modbus RTU device
Device Address	Address of Modbus RTU device
DI Channels	DI channel number
DI Address	Read the start address of the DI data
DO Channels	DO channel number
DO Address	Read the start address of the DO data
AI Channels	AI channel number
AI Address	Read the start address of the AI data

AI Format	AI data format, custom Modbus RTU device only supports 16-bit data length
AI Type	Type of AI
AO Channels	AI channel number
AO Address	Read the start address of the AO data
AO Format	AO data format, custom Modbus RTU device only supports 16-bit data length
AO Type	Type of AO

## 9.2 Device Time parameter description

Through this window, you can change and query the time of GTP-541M. The following are its operation options and field instructions:

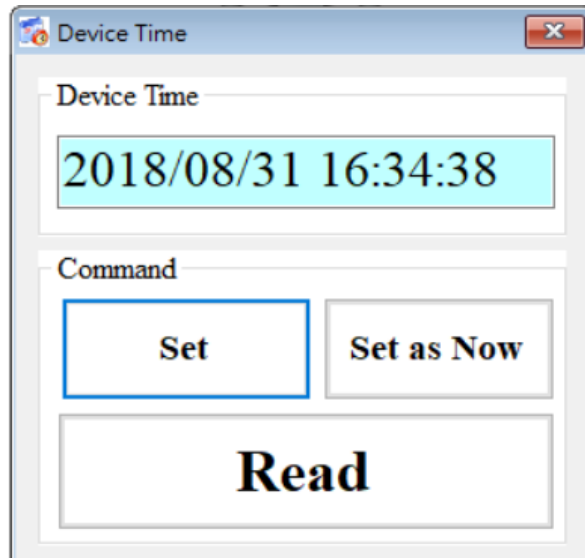

### Field description

◆ Device Time :

Display device current time.

◆ Command :

Set time and read time.

### Operational options description

◆ Set :

The user can enter the date and time into the Device Time field by himself. Set sets the time in the Device Time field to the device.

◆ Set as Now :

Read the current date and time of PC and set it to the device.

◆ Read :

Display device current time.



## 9.3 DO Control AI/DI Status Description

Users can read the I/O status of the current device and manually control the DO status. The operation options and fields are described below.

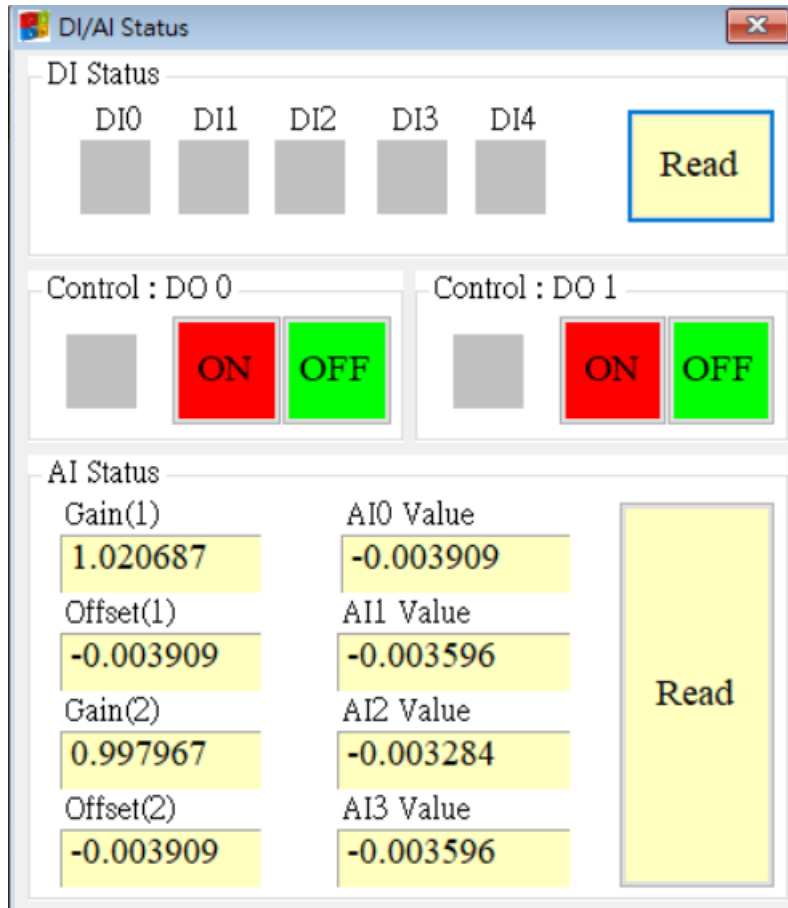

### DI Status

◆ Red :

When DI is ON, the state is low quasi-bit.

◆ Gray :

When DI is OFF, the state is high bit.

◆ Read

Read the DI/DO status.

## **Control : DO0 、 DO1**

### ◆ Red :

When DO is ON, the state is low quasi-bit.

### ◆ Gray :

When DO is OFF, the state is high bit.

### ◆ ON:

Open DO0, DO1.

### ◆ OFF:

Close DO0, DO1.

## **AI Status**

### ◆ AI0(~3) Value :

The current AI reading is in volts (V).

### ◆ Gain(1~2) :

AI correction value, read-only. If Gain is 1 and Offset is 0, please contact us.

### ◆ Offset(1~2) :

AI correction value, read-only. If Gain is 1 and Offset is 0, please contact us.

### ◆ Read:

Read AI voltage value.

## 9.4 Signal Quality Description

This window can be used to query the received signal strength on GTP-541M

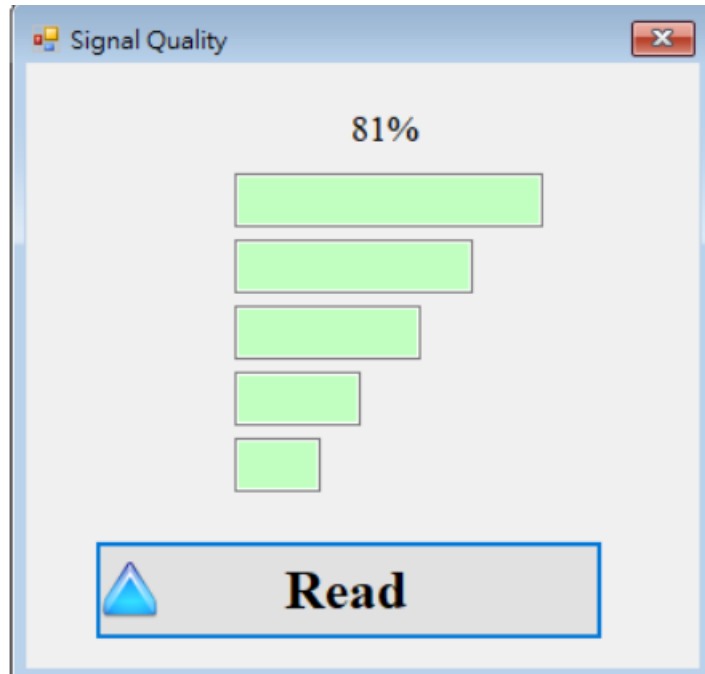

### Signal Quality field description

The signal strength is expressed in 5 segments and the current percentage of the signal strength is shown.

### Operational options description

◆ Read :

Read the current signal strength from GTP-541M.

## 10. Update Firmware Instructions from SD Card

### 一、Place the burned file

Place the version file to be updated in the update folder inside the SD card, and change the name to "fw", as shown in Figure 9.1

名稱	修改日期	類型	大小
fw	2018/8/31 下午 0...	檔案	199 KB

Figure 9.1

二、first insert the SD card that has been placed in the Firmware file into the GTP-541M. After the power is successfully updated, the STA light and the GPS light will flash at the same time every 0.1 seconds for 10 seconds. If the update fails, the update will be The flashing speed is continued for 10 seconds every 0.9 seconds, then the GTP-541M will automatically restart. At this time, the internal file of the SD card will become the internal firmware file and config.ini file of the GTP-541M and the auxiliary file name will be changed to .bak. Figure 9.3

**Note: config.ini.bak is the parameter data used by fw.bak**



Figure 9.2

名稱	修改日期	類型	大小
config.ini.bck	2018/9/4 下午 07	BCK 檔案	21 KB
fw.bck	2018/9/4 下午 07	BCK 檔案	199 KB

Figure 9.3

## 11. GTP-541M Modbus Position Configuration Table

The Modbus Function Codes supported by the GTP-541M are: 1, 2, 3, 4, 5, 6, 15 and 16. The following is the address configuration table :

### (1) Coil Status (Function Code:1, 5, 15)

Address	Data Address	Description	Attribute
00001~ 00128	0x0~ 0x7F	Send alarm number 0~127 corresponding SMS and voice alarm	R/W
00129	0x80	Send a dynamic newsletter	R/W
00200	0xC7	=1, clear the Buffer receiving the newsletter	R/W
00201	0xC8	=1, clear Buffer for sending SMS	R/W
00210	0xD1	=1, save the ModBus data to Flash	R/W

### (2) Discrete Input (Function Code: 2)

Address	Data Address	Description	Attribute
10001	0x0	Is the Buffer that sent the SMS message full? 0: Not full 1: full	R
10002	0x1	Have you received a newsletter? 0: No 1: Yes	R
10003	0x2	Current status of the SD card 0: No SD card or SD card is abnormal 1: normal	R
10004	0x3	Whether it is in Utility mode 0: No 1: yes	R

## (3) Input Register (Function Code: 4)

Address	Data Address	Description	Attribute
30001 ~ 30016	0x0~0xF	Send SMS Buffer No. 0~15 Current Status (1) High Byte: Buffer status 0->Idle 1-> Waiting for transmission 2->Transfer 3->Transfer success 4->Transfer failed (2) Low Byte: error code for transmission failure	R
30017	0x10	Buffer number of the last transmitted SMS	R
30018	0x11	Dynamic messaging status (1) High Byte: Status 0->Idle 1->The system is busy or waiting for transmission 2->Transfer 3->Transfer success 4->Transfer failed (2) Low Byte: Error code for transmission failure	R
30019	0x12	GSM signal strength 0~31 or 99(Error)	R
30028	0x1B	SIM card registration status 0->Not registered 1->Registered 2->Unregistered, looking for 3->Registration rejection 4->Unknown network status 5->Registered, roaming	R
30029	0x1C	Mobile network registration type 0->no service 1->2G 4->3G 8->4G	R

30031 ~ 30040	0x1E~ 0x27	Send the sender's phone number, ASCII code, end the character with 0x00 as the data	R
30041 ~ 30047	0x28~ 0x2E	Time when the newsletter was received, in the format yyyyMMddHHmmss	R
30048	0x2F	Received SMS encoding 0x0000=ASCII 0x0001=Unicode	R
30049~ 30128	0x30~ 0x7F	Received newsletter content ASCII code: end character with 0x00 as data Unicode code: end character with 0x0000 as data	R

Note: The ability to query the delivery status of SMS cannot be used in Edge Trigger mode.

(4) Holding Register(Output Register) (Function Code: 3, 6, 16)

Address	Data Address	Description	Attribute																				
40200	0xC7	Module Address(Modbus Net ID) , 1~247	R/W																				
40201	0xC8	<p>COM1 related settings</p> <p>(1) High Byte</p> <table border="1"> <tr> <td>Code</td> <td>0x04</td> <td>0x05</td> <td>0x06</td> <td>0x07</td> </tr> <tr> <td>Baud</td> <td>2400</td> <td>4800</td> <td>9600</td> <td>19200</td> </tr> <tr> <td>Code</td> <td>0x08</td> <td>0x09</td> <td>0x0A</td> <td></td> </tr> <tr> <td>Baud</td> <td>38400</td> <td>57600</td> <td>115200</td> <td></td> </tr> </table> <p>(2) Low Byte</p> <p>Bit 2:0 (Data Bit) 011 : 8 Data Bits</p> <p>Bite 4:3(stop bit) 00 : 1 stop bit 01 : 2 stop bit</p> <p>Bite 6:5(parity) 00 : no parity 01 : odd parity 10 : even parity</p>	Code	0x04	0x05	0x06	0x07	Baud	2400	4800	9600	19200	Code	0x08	0x09	0x0A		Baud	38400	57600	115200		R/W
Code	0x04	0x05	0x06	0x07																			
Baud	2400	4800	9600	19200																			
Code	0x08	0x09	0x0A																				
Baud	38400	57600	115200																				

400384 ~ 400399	0x17F~ 0x18E	Variable SMS content, Unicode code, ending with 0x0000	R/W
400400 ~ 400469	0x18F~ 0x1D4	Dynamic newsletter content, Unicode code, ending with 0x0000	R/W
400470 ~ 400479	0x1D5 ~ 0x1DE	Dynamic phone number, ASCII code, ending with 0x00	R/W



## Appendix A. Manual Revision History

This chapter provides a revised record of this user manual.

The following table provides the date and description of each revision of this file.

<b>version</b>	<b>publish time</b>	<b>Author</b>	<b>Description</b>
1.0.0	2018/08/31	Jeromy	First release
1.0.1	2018/10/19	Jeromy	Update image
1.0.2	2018/11/13	Jeromy	Modify the error content
1.0.3	2018/11/22	Eddie	Increase ModBusSMS voice alarm function
1.0.4	2018/12/06	Jeromy	Add TXT_SMS Function
1.0.5	2019/04/24	Jeromy	Added DIOSMS voice alert feature